



## **Cannulated Screws, Staples**





# TREU = INSTRUMENTE

## Standard Cannulated Screws Self Drilling / Self Tapping

HOHLSCHRAUBEN  
CANNULATED SCREWS  
TORNILLOS HUECOS

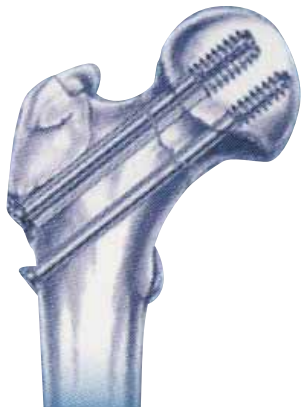

7.0 / 8.0 mm

VIS CREUSES  
VITI CANNULATE



4.5 mm

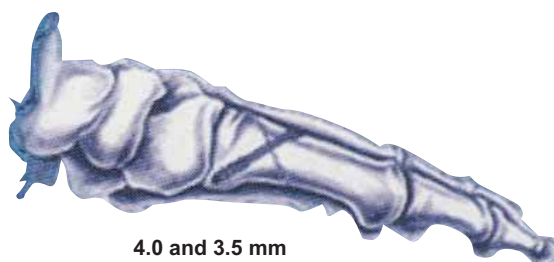

4.0 and 3.5 mm

Rev: 280709



# TREU = INSTRUMENTE

## Cannulated Screws and Instrument Set 7,0 mm Stainless Steel



**T 550** Cannulated Screws and Instrument Set  
**15-1070** Container 465 x 280 x 100 mm  
**15-3068-2** Sieb 405 x 255 x 70 mm

Stainless Steel

Cat. No.:	Description	Quant. in Set
5-800	Cannulated screw ø 7,0 mm / L 30 mm, 16 mm thread, standard	2
5-801	Cannulated screw ø 7,0 mm / L 35 mm, 16 mm thread, standard	2
5-802	Cannulated screw ø 7,0 mm / L 40 mm, 16 mm thread, standard	2
5-803	Cannulated screw ø 7,0 mm / L 45 mm, 16 mm thread, standard	2
5-804	Cannulated screw ø 7,0 mm / L 50 mm, 16 mm thread, standard	2
5-805	Cannulated screw ø 7,0 mm / L 55 mm, 16 mm thread, standard	2
5-806	Cannulated screw ø 7,0 mm / L 60 mm, 16 mm thread, standard	2
5-807	Cannulated screw ø 7,0 mm / L 65 mm, 16 mm thread, standard	2
5-808	Cannulated screw ø 7,0 mm / L 70 mm, 16 mm thread, standard	2
5-809	Cannulated screw ø 7,0 mm / L 75 mm, 16 mm thread, standard	2
5-810	Cannulated screw ø 7,0 mm / L 80 mm, 16 mm thread, standard	4
5-811	Cannulated screw ø 7,0 mm / L 85 mm, 16 mm thread, standard	4
5-812	Cannulated screw ø 7,0 mm / L 90 mm, 16 mm thread, standard	4
5-813	Cannulated screw ø 7,0 mm / L 95 mm, 16 mm thread, standard	2
5-814	Cannulated screw ø 7,0 mm / L 100 mm, 16 mm thread, standard	2
5-815	Cannulated screw ø 7,0 mm / L 105 mm, 16 mm thread, standard	2
5-816	Cannulated screw ø 7,0 mm / L 110 mm, 16 mm thread, standard	2
5-817	Cannulated screw ø 7,0 mm / L 115 mm, 16 mm thread, standard	1
5-818	Cannulated screw ø 7,0 mm / L 120 mm, 16 mm thread, standard	1

Cat. No.:	Description	Quant. in Set
5-820	Cannulated screw ø 7,0 mm / L 45 mm, 32 mm thread, standard	2
5-821	Cannulated screw ø 7,0 mm / L 50 mm, 32 mm thread, standard	2
5-822	Cannulated screw ø 7,0 mm / L 55 mm, 32 mm thread, standard	2
5-823	Cannulated screw ø 7,0 mm / L 60 mm, 32 mm thread, standard	2
5-824	Cannulated screw ø 7,0 mm / L 65 mm, 32 mm thread, standard	2
5-825	Cannulated screw ø 7,0 mm / L 70 mm, 32 mm thread, standard	2
5-826	Cannulated screw ø 7,0 mm / L 75 mm, 32 mm thread, standard	2
5-827	Cannulated screw ø 7,0 mm / L 80 mm, 32 mm thread, standard	2
5-828	Cannulated screw ø 7,0 mm / L 85 mm, 32 mm thread, standard	2
5-829	Cannulated screw ø 7,0 mm / L 90 mm, 32 mm thread, standard	2
5-830	Cannulated screw ø 7,0 mm / L 95 mm, 32 mm thread, standard	1
5-831	Cannulated screw ø 7,0 mm / L 100 mm, 32 mm thread, standard	1
5-832	Cannulated screw ø 7,0 mm / L 105 mm, 32 mm thread, standard	1
5-833	Cannulated screw ø 7,0 mm / L 110 mm, 32 mm thread, standard	1
5-834	Cannulated screw ø 7,0 mm / L 115 mm, 32 mm thread, standard	1
5-835	Cannulated screw ø 7,0 mm / L 120 mm, 32 mm thread, standard	1
5-522	Washer for screws ø 6,5 / 7,0 mm	6

	1 Tray	
5-103	Drill Bit 4.5 x 240 mm ø	1
5-114	Tap 7.0 mm ø	1
5-120	Screw Driver 3.5 mm	1
5-130	Tissue Protector Sleeve	1
5-140	Guide Wire 2.0 mm ø 230 mm	10
4-184	Screw Holding Forceps	1
5-160	Direct Screw Length Gauge for ø 7.0 mm	1
5-180	Cannulated Counter Sink	1
5-164	Canal Cleaner ø 2 mm	1



# TREU = INSTRUMENTE

**Hohlschrauben 7.0 mm**  
**Cannulated Screws 7.0 mm**  
**Tornillos huecos 7.0 mm**  
**vis creuses 7.0 mm**  
**Viti cannulate 7.0 mm**

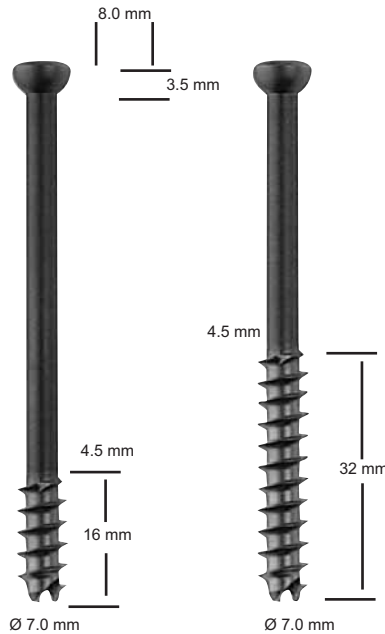

Dia of thread	7,0 mm
Dia of core	4,5 mm
Dia of shaft	4,5 mm
Dia of head	8,0 mm
Pitch	2,75 mm
Cannulation	2,1 mm
Thread Length	16 mm

Dia of thread	7,0 mm
Dia of core	4,5 mm
Dia of shaft	4,5 mm
Dia of head	8,0 mm
Pitch	2,75 mm
Cannulation	2,1 mm
Thread Length	32 mm

Cat. No.:	Screw Length
5-800	30 mm
5-801	35 mm
5-802	40 mm
5-803	45 mm
5-804	50 mm
5-805	55 mm
5-806	60 mm
5-807	65 mm
5-808	70 mm
5-809	75 mm
5-810	80 mm
5-811	85 mm
5-812	90 mm
5-813	95 mm
5-814	100 mm
5-815	105 mm
5-816	110 mm
5-817	115 mm
5-818	120 mm

Cat. No.:	Screw Length
5-820	45 mm
5-821	50 mm
5-822	55 mm
5-823	60 mm
5-824	65 mm
5-825	70 mm
5-826	75 mm
5-827	80 mm
5-828	85 mm
5-829	90 mm
5-830	95 mm
5-831	100 mm
5-832	105 mm
5-833	110 mm
5-834	115 mm
5-835	120 mm

Stainless Steel



Guide Wire with 10 mm thread

**5-140** Guide Wire 2.0 mm  $\varnothing$  for Hollow Screws 7 mm  $\varnothing$  230 mm



# TREU = INSTRUMENTE

## Cannulated Screws and Instrument Set 7,0 mm Titan/Titanium



**T 552** Cannulated Screws and Instrument Set  
**15-1070** Container 465 x 280 x 100 mm  
**15-3068-2** Sieb 405 x 255 x 70 mm

Stainless Steel

Cat.No.:	Description	Quant. in Set
5-80000	Cannulated screw ø 7,0 mm / L 30 mm, 16 mm thread, standard	2
5-80100	Cannulated screw ø 7,0 mm / L 35 mm, 16 mm thread, standard	2
5-80200	Cannulated screw ø 7,0 mm / L 40 mm, 16 mm thread, standard	2
5-80300	Cannulated screw ø 7,0 mm / L 45 mm, 16 mm thread, standard	2
5-80400	Cannulated screw ø 7,0 mm / L 50 mm, 16 mm thread, standard	2
5-80500	Cannulated screw ø 7,0 mm / L 55 mm, 16 mm thread, standard	2
5-80600	Cannulated screw ø 7,0 mm / L 60 mm, 16 mm thread, standard	2
5-80700	Cannulated screw ø 7,0 mm / L 65 mm, 16 mm thread, standard	2
5-80800	Cannulated screw ø 7,0 mm / L 70 mm, 16 mm thread, standard	2
5-80900	Cannulated screw ø 7,0 mm / L 75 mm, 16 mm thread, standard	2
5-81000	Cannulated screw ø 7,0 mm / L 80 mm, 16 mm thread, standard	4
5-81100	Cannulated screw ø 7,0 mm / L 85 mm, 16 mm thread, standard	4
5-81200	Cannulated screw ø 7,0 mm / L 90 mm, 16 mm thread, standard	4
5-81300	Cannulated screw ø 7,0 mm / L 95 mm, 16 mm thread, standard	2
5-81400	Cannulated screw ø 7,0 mm / L 100 mm, 16 mm thread, standard	2
5-81500	Cannulated screw ø 7,0 mm / L 105 mm, 16 mm thread, standard	2
5-81600	Cannulated screw ø 7,0 mm / L 110 mm, 16 mm thread, standard	2
5-81700	Cannulated screw ø 7,0 mm / L 115 mm, 16 mm thread, standard	1
5-81800	Cannulated screw ø 7,0 mm / L 120 mm, 16 mm thread, standard	1

Cat. No.:	Description	Quant. in Set
5-82000	Cannulated screw ø 7,0 mm / L 45 mm, 32 mm thread, standard	2
5-82100	Cannulated screw ø 7,0 mm / L 50 mm, 32 mm thread, standard	2
5-82200	Cannulated screw ø 7,0 mm / L 55 mm, 32 mm thread, standard	2
5-82300	Cannulated screw ø 7,0 mm / L 60 mm, 32 mm thread, standard	2
5-82400	Cannulated screw ø 7,0 mm / L 65 mm, 32 mm thread, standard	2
5-82500	Cannulated screw ø 7,0 mm / L 70 mm, 32 mm thread, standard	2
5-82600	Cannulated screw ø 7,0 mm / L 75 mm, 32 mm thread, standard	2
5-82700	Cannulated screw ø 7,0 mm / L 80 mm, 32 mm thread, standard	2
5-82800	Cannulated screw ø 7,0 mm / L 85 mm, 32 mm thread, standard	2
5-82900	Cannulated screw ø 7,0 mm / L 90 mm, 32 mm thread, standard	2
5-83000	Cannulated screw ø 7,0 mm / L 95 mm, 32 mm thread, standard	1
5-83100	Cannulated screw ø 7,0 mm / L 100 mm, 32 mm thread, standard	1
5-83200	Cannulated screw ø 7,0 mm / L 105 mm, 32 mm thread, standard	1
5-83300	Cannulated screw ø 7,0 mm / L 110 mm, 32 mm thread, standard	1
5-83400	Cannulated screw ø 7,0 mm / L 115 mm, 32 mm thread, standard	1
5-83500	Cannulated screw ø 7,0 mm / L 120 mm, 32 mm thread, standard	1
5-52200	Washer for screws ø 6,5 / 7,0 mm	6

	1 Tray	
5-103	Drill Bit 4.5 mm ø	1
5-114	Tap 7.0 mm ø	1
5-120	Screw Driver 3.5 mm	1
5-130	Tissue Protector Sleeve	1
5-140	Guide Wire 2.0 mm ø 230 mm	10
4-184	Screw Holding Forceps	1
5-160	Direct Screw Length Gauge for ø 7.0 mm	1
5-180	Cannulated Counter Sink	1
5-164	Canal Cleaner ø 2 mm	1



# TREU = INSTRUMENTE

**Hohlschrauben 7.0 mm**  
**Cannulated Screws 7.0 mm**  
**Tornillos huecos 7.0 mm**  
**vis creuses 7.0 mm**  
**Viti cannulate 7.0 mm**

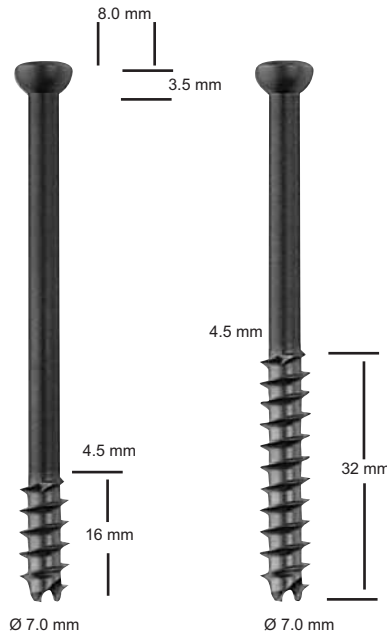

Dia of thread	7,0 mm
Dia of core	4,5 mm
Dia of shaft	4,5 mm
Dia of head	8,0 mm
Pitch	2,75 mm
Cannulation	2,1 mm
Thread Length	16 mm

Dia of thread	7,0 mm
Dia of core	4,5 mm
Dia of shaft	4,5 mm
Dia of head	8,0 mm
Pitch	2,75 mm
Cannulation	2,1 mm
Thread Length	32 mm

Cat. No.:	Screw Length
5-80000	30 mm
5-80100	35 mm
5-80200	40 mm
5-80300	45 mm
5-80400	50 mm
5-80500	55 mm
5-80600	60 mm
5-80700	65 mm
5-80800	70 mm
5-80900	75 mm
5-81000	80 mm
5-81100	85 mm
5-81200	90 mm
5-81300	95 mm
5-81400	100 mm
5-81500	105 mm
5-81600	110 mm
5-81700	115 mm
5-81800	120 mm

Cat. No.:	Screw Length
5-82000	45 mm
5-82100	50 mm
5-82200	55 mm
5-82300	60 mm
5-82400	65 mm
5-82500	70 mm
5-82600	75 mm
5-82700	80 mm
5-82800	85 mm
5-82900	90 mm
5-83000	95 mm
5-83100	100 mm
5-83200	105 mm
5-83300	110 mm
5-83400	115 mm
5-83500	120 mm

TITAN



Guide Wire with 10 mm thread

**5-140** Guide Wire 2.0 mm  $\varnothing$  for Hollow Screws 7 mm  $\varnothing$  230 mm



# TREU = INSTRUMENTE

## Instruments for 7 mm Cannulated Screws



**9-014** Drill Bit  $\varnothing$  2.0 mm x 100/75 mm  
**5-103** Drill Bit  $\varnothing$  4.5 x 240 mm cannulated

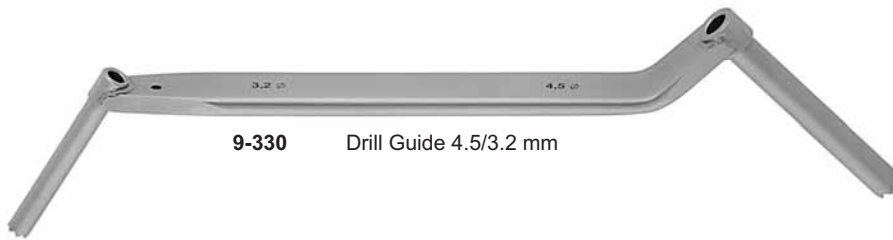

**9-330** Drill Guide 4.5/3.2 mm



**5-180** Cannulated Counter Sink, Length 230 mm

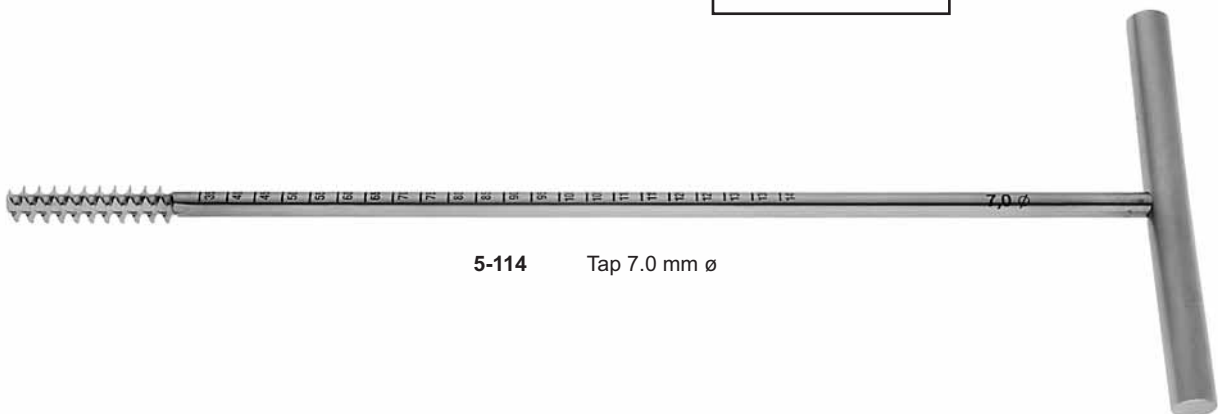

**5-114** Tap 7.0 mm  $\varnothing$



**5-118** 5 mm Screw Driver for 7 mm screws  
**5-120** 3.5 mm Screw Driver cannulated





# TREU - INSTRUMENTE



4-184 Screw Forceps

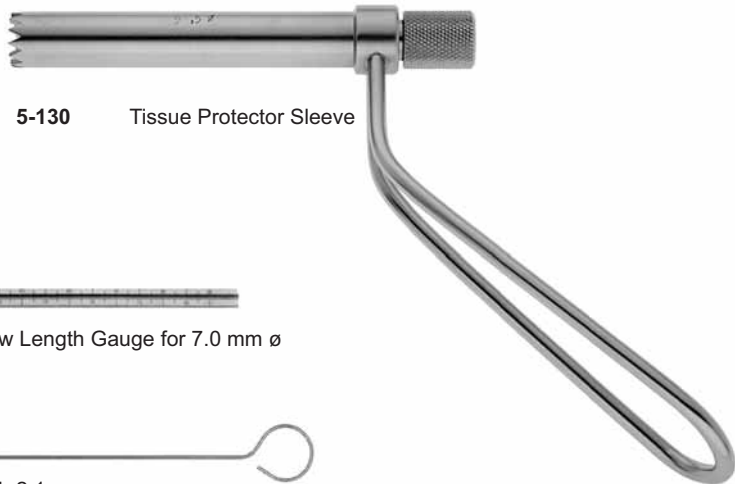

5-130 Tissue Protector Sleeve



5-160 Direct Screw Length Gauge for 7.0 mm ø



5-162 Canal Brush 2.1 mm ø



5-164 Canal Cleaner 2.0 mm ø



5-178 Holding Clamp



#### Washers for Hollow Screws

Stainless

5-132 19 mm ø

5-134 16 mm ø

5-522 13 mm ø

Titan

5-13200 19 mm ø

5-13400 16 mm ø

5-52200 13 mm ø



5-131 Parallel Target Device for Guide Wires ø 2.0 mm



# TREU - INSTRUMENTE

## Cannulated Screws and Instrument Set 7,0 mm

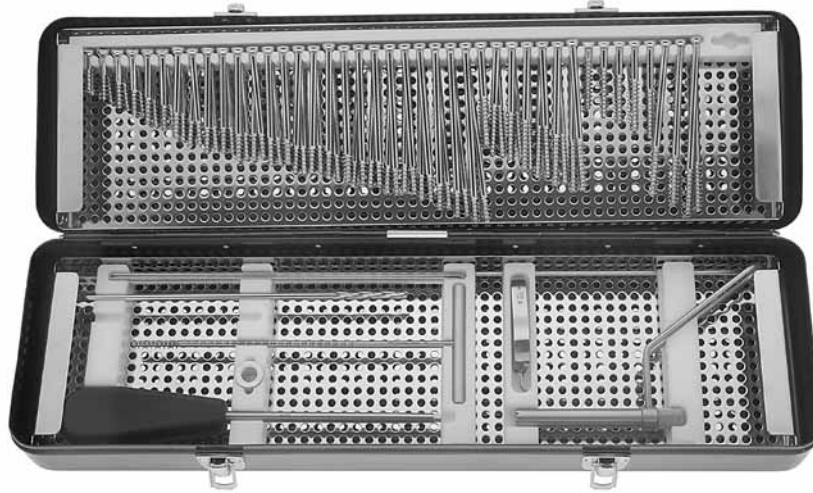

- T 500** Cannulated Screws and Instrument Set
- T 111** Aluminium Case
- T 501** Upper Tray
- T 502** Lower Tray

Stainless Steel

Cat. No.:	Description	Quant. in Set
5-002	Cannulated screw ø 7,0 mm / L 30 mm, 16 mm thread, standard	2
5-003	Cannulated screw ø 7,0 mm / L 35 mm, 16 mm thread, standard	2
5-004	Cannulated screw ø 7,0 mm / L 40 mm, 16 mm thread, standard	2
5-005	Cannulated screw ø 7,0 mm / L 45 mm, 16 mm thread, standard	2
5-006	Cannulated screw ø 7,0 mm / L 50 mm, 16 mm thread, standard	2
5-007	Cannulated screw ø 7,0 mm / L 55 mm, 16 mm thread, standard	2
5-008	Cannulated screw ø 7,0 mm / L 60 mm, 16 mm thread, standard	2
5-009	Cannulated screw ø 7,0 mm / L 65 mm, 16 mm thread, standard	2
5-010	Cannulated screw ø 7,0 mm / L 70 mm, 16 mm thread, standard	2
5-011	Cannulated screw ø 7,0 mm / L 75 mm, 16 mm thread, standard	2
5-012	Cannulated screw ø 7,0 mm / L 80 mm, 16 mm thread, standard	4
5-013	Cannulated screw ø 7,0 mm / L 85 mm, 16 mm thread, standard	4
5-014	Cannulated screw ø 7,0 mm / L 90 mm, 16 mm thread, standard	4
5-015	Cannulated screw ø 7,0 mm / L 95 mm, 16 mm thread, standard	2
5-016	Cannulated screw ø 7,0 mm / L 100 mm, 16 mm thread, standard	2
5-017	Cannulated screw ø 7,0 mm / L 105 mm, 16 mm thread, standard	2
5-018	Cannulated screw ø 7,0 mm / L 110 mm, 16 mm thread, standard	2
5-019	Cannulated screw ø 7,0 mm / L 115 mm, 16 mm thread, standard	1
5-020	Cannulated screw ø 7,0 mm / L 120 mm, 16 mm thread, standard	1
5-021	Cannulated screw ø 7,0 mm / L 125 mm, 16 mm thread, standard	1
5-022	Cannulated screw ø 7,0 mm / L 130 mm, 16 mm thread, standard	1

Cat. No.:	Description	Quant. in Set
5-031	Cannulated screw ø 7,0 mm / L 45 mm, 32 mm thread, standard	2
5-032	Cannulated screw ø 7,0 mm / L 50 mm, 32 mm thread, standard	2
5-033	Cannulated screw ø 7,0 mm / L 55 mm, 32 mm thread, standard	2
5-034	Cannulated screw ø 7,0 mm / L 60 mm, 32 mm thread, standard	2
5-035	Cannulated screw ø 7,0 mm / L 65 mm, 32 mm thread, standard	2
5-036	Cannulated screw ø 7,0 mm / L 70 mm, 32 mm thread, standard	2
5-037	Cannulated screw ø 7,0 mm / L 75 mm, 32 mm thread, standard	2
5-038	Cannulated screw ø 7,0 mm / L 80 mm, 32 mm thread, standard	2
5-039	Cannulated screw ø 7,0 mm / L 85 mm, 32 mm thread, standard	2
5-040	Cannulated screw ø 7,0 mm / L 90 mm, 32 mm thread, standard	2
5-041	Cannulated screw ø 7,0 mm / L 95 mm, 32 mm thread, standard	1
5-042	Cannulated screw ø 7,0 mm / L 100 mm, 32 mm thread, standard	1
5-043	Cannulated screw ø 7,0 mm / L 105 mm, 32 mm thread, standard	1
5-044	Cannulated screw ø 7,0 mm / L 110 mm, 32 mm thread, standard	1
5-045	Cannulated screw ø 7,0 mm / L 115 mm, 32 mm thread, standard	1
5-046	Cannulated screw ø 7,0 mm / L 120 mm, 32 mm thread, standard	1
5-047	Cannulated screw ø 7,0 mm / L 125 mm, 32 mm thread, standard	1
5-048	Cannulated screw ø 7,0 mm / L 130 mm, 32 mm thread, standard	1
5-522	Washer for screws ø 6,5 / 7,0 mm	6

	1 Tray	
5-100	Drill Bit 5.0 mm ø	1
5-114	Tap 7.0 mm ø	1
5-118	Screw Driver	1
5-130	Tissue Protector Sleeve	1
5-140	Guide Wire 2.0 mm ø 230 mm	10
4-184	Screw Holding Forceps	1
5-160	Direct Screws Length Gauge for ø 7.0 mm	1
5-180	Cannulated Counter Sink	1
5-164	Canal Cleaner ø 2 mm	1



# TREU = INSTRUMENTE

## Cannulated Screws



7 mm  $\varnothing$  with over flats SW 5.0 mm  
16 mm length of thread, drill bit 5.0 mm  
stainless steel

Cat. No.:	Screw Length
5-002	30 mm
5-003	35 mm
5-004	40 mm
5-005	45 mm
5-006	50 mm
5-007	55 mm
5-008	60 mm
5-009	65 mm
5-010	70 mm
5-011	75 mm
5-012	80 mm
5-013	85 mm
5-014	90 mm
5-015	95 mm
5-016	100 mm
5-017	105 mm
5-018	110 mm
5-019	115 mm
5-020	120 mm
5-021	125 mm
5-022	130 mm



7 mm  $\varnothing$  with over flats SW 5.0 mm  
32 mm length of thread, drill bit 5.0 mm  
stainless steel

Cat. No.:	Screw Length
5-031	45 mm
5-032	50 mm
5-033	55 mm
5-034	60 mm
5-035	65 mm
5-036	70 mm
5-037	75 mm
5-038	80 mm
5-039	85 mm
5-040	90 mm
5-041	95 mm
5-042	100 mm
5-043	105 mm
5-044	110 mm
5-045	115 mm
5-046	120 mm
5-047	125 mm
5-048	130 mm



7 mm  $\varnothing$  with over flats SW 5.0 mm  
full threaded, drill bit 5.0 mm  
stainless steel

Cat. No.:	Screw Length
5-270	45 mm
5-271	50 mm
5-272	55 mm
5-273	60 mm
5-274	65 mm
5-275	70 mm
5-276	75 mm
5-277	80 mm
5-278	85 mm
5-279	90 mm
5-280	95 mm
5-281	100 mm
5-282	105 mm
5-283	110 mm
5-284	115 mm
5-285	120 mm
5-286	125 mm
5-287	130 mm



Guide Wire with 10 mm thread

**5-140** Guide Wire 2.0 mm  $\varnothing$  for Hollow Screws 7 mm  $\varnothing$  230 mm



# TREU = INSTRUMENTE

## Instruments for 7 mm Cannulated Screws



5-100 Drill Bit  $\varnothing$  5.0 mm 180 mm



5-180 Cannulated Counter Sink, Length 230 mm

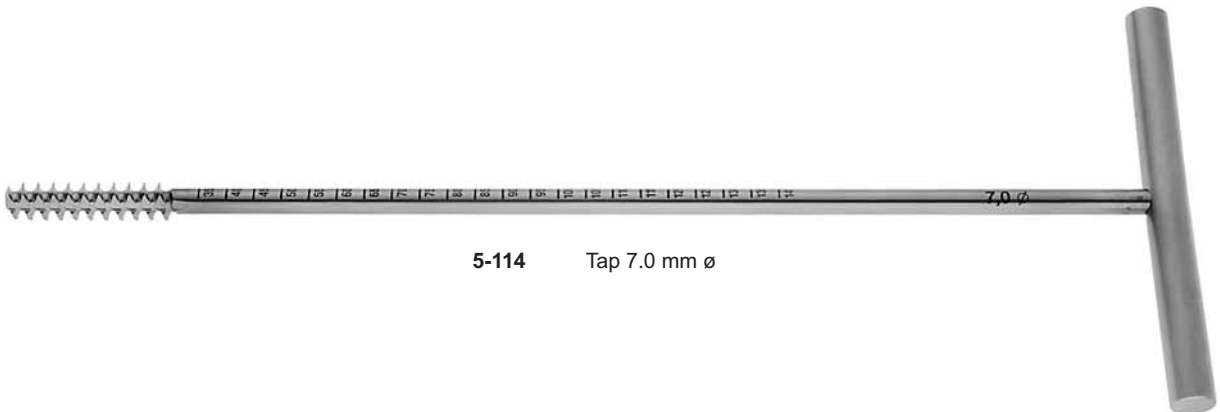

5-114 Tap 7.0 mm  $\varnothing$



5-118 5 mm Screw Driver for 7 mm screws



# TREU - INSTRUMENTE

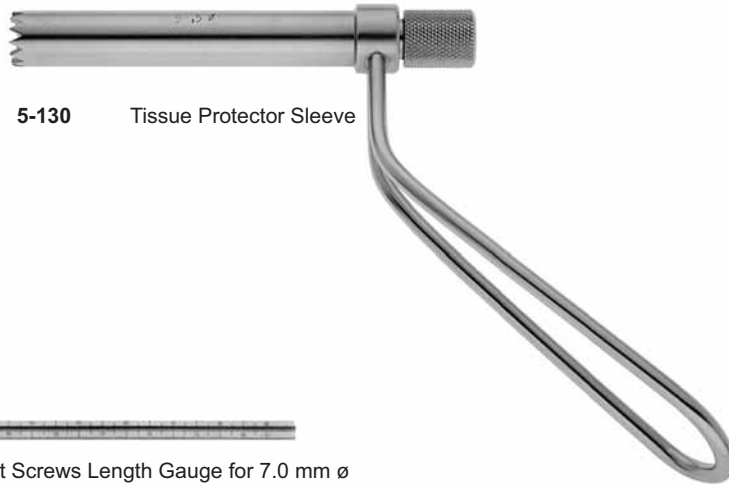

5-130 Tissue Protector Sleeve

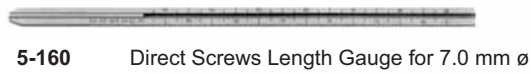

5-160 Direct Screws Length Gauge for 7.0 mm  $\varnothing$



5-162 Canal Brush 2.1 mm  $\varnothing$



5-164 Canal Cleaner 2.0 mm  $\varnothing$



5-178 Holding Clamp



Washers for Hollow Screws

- 5-132 19 mm  $\varnothing$
- 5-134 16 mm  $\varnothing$
- 5-522 13 mm  $\varnothing$



5-131 Parallel Target Device for Guide Wires  $\varnothing$  2.0 mm



# TREU = INSTRUMENTE

## T 520 Cannulated Screws and Instrument Set for 4.5 mm Screws Stainless Steel

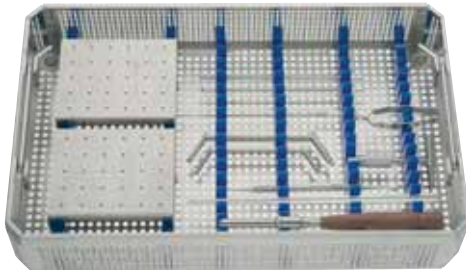

**15-1070**

Container 465 x 280 x 100 mm

**15-3068-1**

Sieb 405 x 255 x 70 mm

### Set contents of implants

Cat. No.:	Description	Quant. in Set
5-200	Cannulated screw ø 4,5 mm / L 20 mm, short thread, self-tapping	3
5-201	Cannulated screw ø 4,5 mm / L 22 mm, short thread, self-tapping	3
5-202	Cannulated screw ø 4,5 mm / L 24 mm, short thread, self-tapping	3
5-203	Cannulated screw ø 4,5 mm / L 26 mm, short thread, self-tapping	3
5-204	Cannulated screw ø 4,5 mm / L 28 mm, short thread, self-tapping	3
5-205	Cannulated screw ø 4,5 mm / L 30 mm, short thread, self-tapping	3
5-206	Cannulated screw ø 4,5 mm / L 32 mm, short thread, self-tapping	3
5-207	Cannulated screw ø 4,5 mm / L 34 mm, short thread, self-tapping	3
5-208	Cannulated screw ø 4,5 mm / L 36 mm, short thread, self-tapping	3
5-209	Cannulated screw ø 4,5 mm / L 38 mm, short thread, self-tapping	3
5-210	Cannulated screw ø 4,5 mm / L 40 mm, short thread, self-tapping	3
5-211	Cannulated screw ø 4,5 mm / L 42 mm, short thread, self-tapping	3
5-212	Cannulated screw ø 4,5 mm / L 44 mm, short thread, self-tapping	3
5-213	Cannulated screw ø 4,5 mm / L 46 mm, short thread, self-tapping	3
5-214	Cannulated screw ø 4,5 mm / L 48 mm, short thread, self-tapping	3
5-215	Cannulated screw ø 4,5 mm / L 50 mm, short thread, self-tapping	3
5-216	Cannulated screw ø 4,5 mm / L 52 mm, short thread, self-tapping	3
5-217	Cannulated screw ø 4,5 mm / L 54 mm, short thread, self-tapping	3
5-218	Cannulated screw ø 4,5 mm / L 56 mm, short thread, self-tapping	3
5-219	Cannulated screw ø 4,5 mm / L 58 mm, short thread, self-tapping	3
5-220	Cannulated screw ø 4,5 mm / L 60 mm, short thread, self-tapping	3

Cat. No.:	Description	Quant. in Set
5-230	Cannulated screw ø 4,5 mm / L 20 mm, fully thread, self-tapping	3
5-231	Cannulated screw ø 4,5 mm / L 22 mm, fully thread, self-tapping	3
5-232	Cannulated screw ø 4,5 mm / L 24 mm, fully thread, self-tapping	3
5-233	Cannulated screw ø 4,5 mm / L 26 mm, fully thread, self-tapping	3
5-234	Cannulated screw ø 4,5 mm / L 28 mm, fully thread, self-tapping	3
5-235	Cannulated screw ø 4,5 mm / L 30 mm, fully thread, self-tapping	3
5-236	Cannulated screw ø 4,5 mm / L 32 mm, fully thread, self-tapping	3
5-237	Cannulated screw ø 4,5 mm / L 34 mm, fully thread, self-tapping	3
5-238	Cannulated screw ø 4,5 mm / L 36 mm, fully thread, self-tapping	3
5-239	Cannulated screw ø 4,5 mm / L 38 mm, fully thread, self-tapping	3
5-240	Cannulated screw ø 4,5 mm / L 40 mm, fully thread, self-tapping	3
5-241	Cannulated screw ø 4,5 mm / L 42 mm, fully thread, self-tapping	3
5-242	Cannulated screw ø 4,5 mm / L 44 mm, fully thread, self-tapping	3
5-243	Cannulated screw ø 4,5 mm / L 46 mm, fully thread, self-tapping	3
5-244	Cannulated screw ø 4,5 mm / L 48 mm, fully thread, self-tapping	3
5-245	Cannulated screw ø 4,5 mm / L 50 mm, fully thread, self-tapping	3
5-246	Cannulated screw ø 4,5 mm / L 52 mm, fully thread, self-tapping	3
5-247	Cannulated screw ø 4,5 mm / L 54 mm, fully thread, self-tapping	3
5-248	Cannulated screw ø 4,5 mm / L 56 mm, fully thread, self-tapping	3
5-249	Cannulated screw ø 4,5 mm / L 58 mm, fully thread, self-tapping	3
5-250	Cannulated screw ø 4,5 mm / L 60 mm, fully thread, self-tapping	3
3-520	Washer 11 x 4,8 mm	5

<b>5-260</b>	Guide Wire ø 1,6 mm for hollow Screws ø 4,5 mm, 230 mm length	10
<b>9-330</b>	Tap and Drill Sleeve 4,5 / 32 mm	1
<b>5-120</b>	Screw Driver cannulated for 4,5 mm Screws	1
<b>5-192</b>	Tap for 4,5 mm cannulated screws AO	1
<b>5-187</b>	Drill bit ø 4,5 mm cannulated 1,8 mm	1
<b>5-189</b>	Drill bit ø 3,2 mm cannulated 1,8 mm	1
<b>9-093</b>	Cannulated T-shaped handle with quick coupling	1
<b>9-166</b>	Screw Driver Sleeve f. 5-120	1

<b>5-182</b>	cannulated counter sink for 4,5 mm screws with quick coupling	1
<b>4-184</b>	screw forceps self holding	1
<b>5-166</b>	direct screw length gauge	1
<b>5-168</b>	Canal brush ø 1,75 mm	1
<b>5-170</b>	Canal cleaner 1,6 mm	1
<b>5-178</b>	holding clamp	1
<b>9-334</b>	Tap and drill sleeve 3,5 / 2,5 mm	1
<b>T 317</b>	Rack for ø 4,5 mm screws	2



# TREU = INSTRUMENTE

## T 522 Cannulated Screws and Instrument Set for 4.5 mm Screws Titan/Titanium

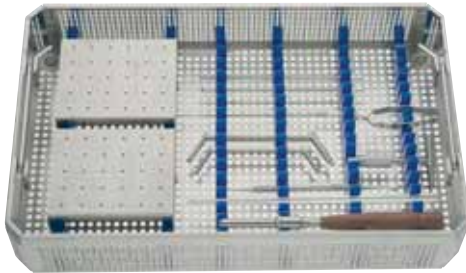

**15-1070**

Container 465 x 280 x 100 mm

**15-3068-1**

Sieb 405 x 255 x 70 mm

### Set contents of implants

Cat. No.:	Description	Quant. in Set
5-20000	Cannulated screw ø 4,5 mm / L 20 mm, short thread, self-tapping	3
5-20100	Cannulated screw ø 4,5 mm / L 22 mm, short thread, self-tapping	3
5-20200	Cannulated screw ø 4,5 mm / L 24 mm, short thread, self-tapping	3
5-20300	Cannulated screw ø 4,5 mm / L 26 mm, short thread, self-tapping	3
5-20400	Cannulated screw ø 4,5 mm / L 28 mm, short thread, self-tapping	3
5-20500	Cannulated screw ø 4,5 mm / L 30 mm, short thread, self-tapping	3
5-20600	Cannulated screw ø 4,5 mm / L 32 mm, short thread, self-tapping	3
5-20700	Cannulated screw ø 4,5 mm / L 34 mm, short thread, self-tapping	3
5-20800	Cannulated screw ø 4,5 mm / L 36 mm, short thread, self-tapping	3
5-20900	Cannulated screw ø 4,5 mm / L 38 mm, short thread, self-tapping	3
5-21000	Cannulated screw ø 4,5 mm / L 40 mm, short thread, self-tapping	3
5-21100	Cannulated screw ø 4,5 mm / L 42 mm, short thread, self-tapping	3
5-21200	Cannulated screw ø 4,5 mm / L 44 mm, short thread, self-tapping	3
5-21300	Cannulated screw ø 4,5 mm / L 46 mm, short thread, self-tapping	3
5-21400	Cannulated screw ø 4,5 mm / L 48 mm, short thread, self-tapping	3
5-21500	Cannulated screw ø 4,5 mm / L 50 mm, short thread, self-tapping	3
5-21600	Cannulated screw ø 4,5 mm / L 52 mm, short thread, self-tapping	3
5-21700	Cannulated screw ø 4,5 mm / L 54 mm, short thread, self-tapping	3
5-21800	Cannulated screw ø 4,5 mm / L 56 mm, short thread, self-tapping	3
5-21900	Cannulated screw ø 4,5 mm / L 58 mm, short thread, self-tapping	3
5-22000	Cannulated screw ø 4,5 mm / L 60 mm, short thread, self-tapping	3

Cat. No.:	Description	Quant. in Set
5-23000	Cannulated screw ø 4,5 mm / L 20 mm, fully thread, self-tapping	3
5-23100	Cannulated screw ø 4,5 mm / L 22 mm, fully thread, self-tapping	3
5-23200	Cannulated screw ø 4,5 mm / L 24 mm, fully thread, self-tapping	3
5-23300	Cannulated screw ø 4,5 mm / L 26 mm, fully thread, self-tapping	3
5-23400	Cannulated screw ø 4,5 mm / L 28 mm, fully thread, self-tapping	3
5-23500	Cannulated screw ø 4,5 mm / L 30 mm, fully thread, self-tapping	3
5-23600	Cannulated screw ø 4,5 mm / L 32 mm, fully thread, self-tapping	3
5-23700	Cannulated screw ø 4,5 mm / L 34 mm, fully thread, self-tapping	3
5-23800	Cannulated screw ø 4,5 mm / L 36 mm, fully thread, self-tapping	3
5-23900	Cannulated screw ø 4,5 mm / L 38 mm, fully thread, self-tapping	3
5-24000	Cannulated screw ø 4,5 mm / L 40 mm, fully thread, self-tapping	3
5-24100	Cannulated screw ø 4,5 mm / L 42 mm, fully thread, self-tapping	3
5-24200	Cannulated screw ø 4,5 mm / L 44 mm, fully thread, self-tapping	3
5-24300	Cannulated screw ø 4,5 mm / L 46 mm, fully thread, self-tapping	3
5-24400	Cannulated screw ø 4,5 mm / L 48 mm, fully thread, self-tapping	3
5-24500	Cannulated screw ø 4,5 mm / L 50 mm, fully thread, self-tapping	3
5-24600	Cannulated screw ø 4,5 mm / L 52 mm, fully thread, self-tapping	3
5-24700	Cannulated screw ø 4,5 mm / L 54 mm, fully thread, self-tapping	3
5-24800	Cannulated screw ø 4,5 mm / L 56 mm, fully thread, self-tapping	3
5-24900	Cannulated screw ø 4,5 mm / L 58 mm, fully thread, self-tapping	3
5-25000	Cannulated screw ø 4,5 mm / L 60 mm, fully thread, self-tapping	3
3-52000	Washer 11 x 4,8 mm	5

<b>5-260</b>	Guide Wire ø 1,6 mm for hollow Screws ø 4,5 mm, 230 mm length	10
<b>9-330</b>	Tap and Drill Sleeve 4,5 / 32 mm	1
<b>5-120</b>	Screw Driver cannulated for 4,5 mm Screws	1
<b>5-192</b>	Tap for 4,5 mm cannulated screws AO	1
<b>5-187</b>	Drill bit ø 4,5 mm cannulated 1,8 mm	1
<b>5-189</b>	Drill bit ø 3,2 mm cannulated 1,8 mm	1
<b>9-093</b>	Cannulated T-shaped handle with quick coupling	1
<b>9-166</b>	Screw Driver Sleeve f. 5-120	1

<b>5-182</b>	cannulated counter sink for 4,5 mm screws with quick coupling	1
<b>4-184</b>	screw forceps self holding	1
<b>5-166</b>	direct screw length gauge	1
<b>5-168</b>	Canal brush ø 1,75 mm	1
<b>5-170</b>	Canal cleaner 1,6 mm	1
<b>5-178</b>	holding clamp	1
<b>9-334</b>	Tap and drill sleeve 3,5 / 2,5 mm	1
<b>T 317</b>	Rack for ø 4,5 mm screws	2



# TREU = INSTRUMENTE

## Cannulated Screws ø 4.5 mm

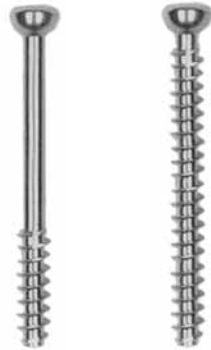

Stainless Steel

Dia of thread	4.5 mm	4.5 mm
Dia of core	3,0 mm	3.0 mm
Dia of shaft	3,0 mm	
Dia of head	6,5 mm	6,5 mm
Cannulation	1,75 mm	1,75 mm
Pitch	1,75 mm	1,75 mm
Hexagon	3,5 mm	3,5 mm
Length		
20 mm	<b>5-200</b>	<b>5-230</b>
22 mm	<b>5-201</b>	<b>5-231</b>
24 mm	<b>5-202</b>	<b>5-232</b>
26 mm	<b>5-203</b>	<b>5-233</b>
28 mm	<b>5-204</b>	<b>5-234</b>
30 mm	<b>5-205</b>	<b>5-235</b>
32 mm	<b>5-206</b>	<b>5-236</b>
34 mm	<b>5-207</b>	<b>5-237</b>
36 mm	<b>5-208</b>	<b>5-238</b>
38 mm	<b>5-209</b>	<b>5-239</b>
40 mm	<b>5-210</b>	<b>5-240</b>
42 mm	<b>5-211</b>	<b>5-241</b>
44 mm	<b>5-212</b>	<b>5-242</b>
46 mm	<b>5-213</b>	<b>5-243</b>
48 mm	<b>5-214</b>	<b>5-244</b>
50 mm	<b>5-215</b>	<b>5-245</b>
52 mm	<b>5-216</b>	<b>5-246</b>
54 mm	<b>5-217</b>	<b>5-247</b>
56 mm	<b>5-218</b>	<b>5-248</b>
58 mm	<b>5-219</b>	<b>5-249</b>
60 mm	<b>5-220</b>	<b>5-250</b>

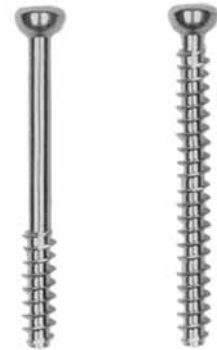

Titan/Titanium

Dia of thread	4.5 mm	4.5 mm
Dia of core	3,0 mm	3.0 mm
Dia of shaft	3,0 mm	
Dia of head	6,5 mm	6,5 mm
Cannulation	1,75 mm	1,75 mm
Pitch	1,75 mm	1,75 mm
Hexagon	3,5 mm	3,5 mm
Length		
20 mm	<b>5-20000</b>	<b>5-23000</b>
22 mm	<b>5-20100</b>	<b>5-23100</b>
24 mm	<b>5-20200</b>	<b>5-23200</b>
26 mm	<b>5-20300</b>	<b>5-23300</b>
28 mm	<b>5-20400</b>	<b>5-23400</b>
30 mm	<b>5-20500</b>	<b>5-23500</b>
32 mm	<b>5-20600</b>	<b>5-23600</b>
34 mm	<b>5-20700</b>	<b>5-23700</b>
36 mm	<b>5-20800</b>	<b>5-23800</b>
38 mm	<b>5-20900</b>	<b>5-23900</b>
40 mm	<b>5-21000</b>	<b>5-24000</b>
42 mm	<b>5-21100</b>	<b>5-24100</b>
44 mm	<b>5-21200</b>	<b>5-24200</b>
46 mm	<b>5-21300</b>	<b>5-24300</b>
48 mm	<b>5-21400</b>	<b>5-24400</b>
50 mm	<b>5-21500</b>	<b>5-24500</b>
52 mm	<b>5-21600</b>	<b>5-24600</b>
54 mm	<b>5-21700</b>	<b>5-24700</b>
56 mm	<b>5-21800</b>	<b>5-24800</b>
58 mm	<b>5-21900</b>	<b>5-24900</b>
60 mm	<b>5-22000</b>	<b>5-25000</b>

Guide Wire with 10 mm thread

**5-260** Guide Wire 1.6 mm ø for Hollow Screws ø 4,5 mm, 230 mm



**3-520** Stainless Steel  
**3-52000** Titan/Titanium  
 Washers  
 11,0 x 4,8 mm





# TREU = INSTRUMENTE

## Instruments for 4.5 mm Cannulated Screws

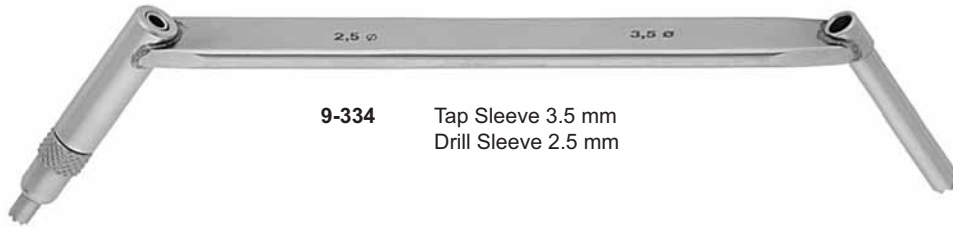

**9-334** Tap Sleeve 3.5 mm  
Drill Sleeve 2.5 mm



**9-166** Sleeve for 5-120 Driver



**5-120** Screw Driver for 4.5 mm cannulated screws 225 mm



**5-192** Tap for 4.5 mm cannulated screws 160 mm



**9-093** Tap Handle  
cannulated



**5-187** Cannulated Drill Bit 160 mm length  
Drill Bit  $\varnothing$  4.5 mm / 1.8 mm

**5-189** Drill Bit  $\varnothing$  3.2 mm / 1.8 mm

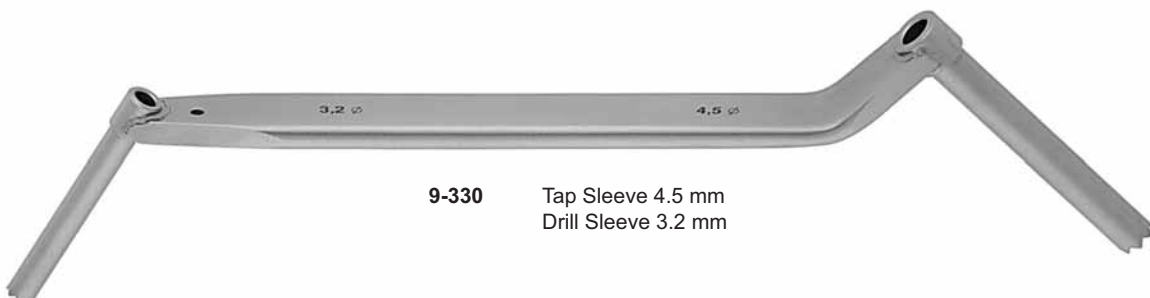

**9-330** Tap Sleeve 4.5 mm  
Drill Sleeve 3.2 mm



# TREU = INSTRUMENTE

## Instruments for cannulated Screws



5-182 Cannulated Counter Sink for 4,5 mm screws



4-184 Screw Forceps



9-116 Sharp Hook  
for checking of fracture ends and  
for removing in grown tissue in screw heads



5-166 Direct Screw Length Gauge for 4.5 mm ø



5-168 Canal Brush 1.75 mm ø

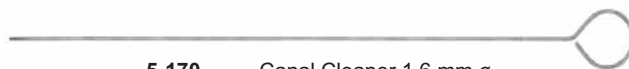

5-170 Canal Cleaner 1.6 mm ø



5-178 Holding Clamp



T 314 Rack for ø 3,5 mm screws



# TREU = INSTRUMENTE

## T 510 Cannulated Screws and Instrument Set for 3.5 mm Screws Stainless Steel

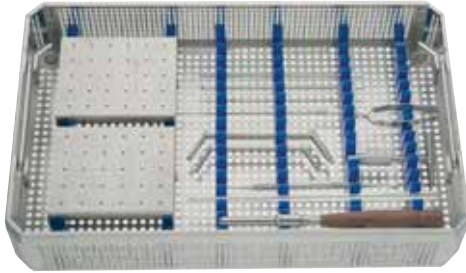

**15-1070**

Container 465 x 280 x 100 mm

**15-3068-1**

Sieb 405 x 255 x 70 mm

### Set contents of implants

Cat. No.:	Description	Quant. in Set
5-300	Cannulated screw ø 3,5 mm / L 10 mm, short thread, self-tapping	3
5-302	Cannulated screw ø 3,5 mm / L 12 mm, short thread, self-tapping	3
5-304	Cannulated screw ø 3,5 mm / L 14 mm, short thread, self-tapping	3
5-306	Cannulated screw ø 3,5 mm / L 16 mm, short thread, self-tapping	3
5-308	Cannulated screw ø 3,5 mm / L 18 mm, short thread, self-tapping	3
5-310	Cannulated screw ø 3,5 mm / L 20 mm, short thread, self-tapping	3
5-312	Cannulated screw ø 3,5 mm / L 22 mm, short thread, self-tapping	3
5-314	Cannulated screw ø 3,5 mm / L 24 mm, short thread, self-tapping	3
5-316	Cannulated screw ø 3,5 mm / L 26 mm, short thread, self-tapping	3
5-318	Cannulated screw ø 3,5 mm / L 28 mm, short thread, self-tapping	3
5-320	Cannulated screw ø 3,5 mm / L 30 mm, short thread, self-tapping	3
5-322	Cannulated screw ø 3,5 mm / L 32 mm, short thread, self-tapping	3
5-324	Cannulated screw ø 3,5 mm / L 34 mm, short thread, self-tapping	3
5-326	Cannulated screw ø 3,5 mm / L 36 mm, short thread, self-tapping	3
5-328	Cannulated screw ø 3,5 mm / L 38 mm, short thread, self-tapping	3
5-330	Cannulated screw ø 3,5 mm / L 40 mm, short thread, self-tapping	3
5-332	Cannulated screw ø 3,5 mm / L 42 mm, short thread, self-tapping	3
5-334	Cannulated screw ø 3,5 mm / L 44 mm, short thread, self-tapping	3
5-336	Cannulated screw ø 3,5 mm / L 46 mm, short thread, self-tapping	3
5-338	Cannulated screw ø 3,5 mm / L 48 mm, short thread, self-tapping	3
5-340	Cannulated screw ø 3,5 mm / L 50 mm, short thread, self-tapping	3

Cat. No.:	Description	Quant. in Set
5-342	Cannulated screw ø 3,5 mm / L 10 mm, fully threaded, self-tapping	3
5-344	Cannulated screw ø 3,5 mm / L 12 mm, fully threaded, self-tapping	3
5-346	Cannulated screw ø 3,5 mm / L 14 mm, fully threaded, self-tapping	3
5-348	Cannulated screw ø 3,5 mm / L 16 mm, fully threaded, self-tapping	3
5-350	Cannulated screw ø 3,5 mm / L 18 mm, fully threaded, self-tapping	3
5-352	Cannulated screw ø 3,5 mm / L 20 mm, fully threaded, self-tapping	3
5-354	Cannulated screw ø 3,5 mm / L 22 mm, fully threaded, self-tapping	3
5-356	Cannulated screw ø 3,5 mm / L 24 mm, fully threaded, self-tapping	3
5-358	Cannulated screw ø 3,5 mm / L 26 mm, fully threaded, self-tapping	3
5-360	Cannulated screw ø 3,5 mm / L 28 mm, fully threaded, self-tapping	3
5-362	Cannulated screw ø 3,5 mm / L 30 mm, fully threaded, self-tapping	3
5-364	Cannulated screw ø 3,5 mm / L 32 mm, fully threaded, self-tapping	3
5-366	Cannulated screw ø 3,5 mm / L 34 mm, fully threaded, self-tapping	3
5-368	Cannulated screw ø 3,5 mm / L 36 mm, fully threaded, self-tapping	3
5-370	Cannulated screw ø 3,5 mm / L 38 mm, fully threaded, self-tapping	3
5-372	Cannulated screw ø 3,5 mm / L 40 mm, fully threaded, self-tapping	3
5-374	Cannulated screw ø 3,5 mm / L 42 mm, fully threaded, self-tapping	3
5-376	Cannulated screw ø 3,5 mm / L 44 mm, fully threaded, self-tapping	3
5-378	Cannulated screw ø 3,5 mm / L 46 mm, fully threaded, self-tapping	3
5-380	Cannulated screw ø 3,5 mm / L 48 mm, fully threaded, self-tapping	3
5-382	Cannulated screw ø 3,5 mm / L 50 mm, fully threaded, self-tapping	3
4-176	Washer 7,0 x 3,8 mm	5

<b>9-334</b>	Tap Sleeve 3,5 mm		
	Drill Sleeve 2,5 mm	1	
<b>9-168</b>	Screw Driver Sleeve for 5-122	1	
<b>5-194</b>	Tap for 3,5 mm cannulated Screws	1	
<b>5-188</b>	Drill bit 3,5 mm / 1,4 mm cannulated	1	
<b>5-190</b>	Drill bit 2,7 mm / 1,4 mm cannulated	1	
<b>9-093</b>	Cannulated Tap Handle	1	
<b>5-126</b>	Tap Sleeve 2,7 mm / Drill Sleeve 1,3 mm	1	
<b>5-184</b>	Cannulated Counter sink for 3,5 mm and 4,0 mm screws	1	
<b>5-122</b>	Screw Driver f cannulated Screws	1	
<b>5-135</b>	Guide Wire 1,2 x 150 mm	10	

<b>5-172</b>	Direct Screw length Gauge for 3,5 mm	1
<b>5-174</b>	Canal Brush ø 1,35 mm	1
<b>5-176</b>	Canal cleaner ø 1,2 mm	1
<b>4-184</b>	Screw forceps	1
<b>9-116</b>	Sharp Hook	1
<b>5-178</b>	Holding Clamps	1
<b>T 314</b>	Rack for ø 3,5 mm screws	2



# TREU = INSTRUMENTE

## T 512 Cannulated Screws and Instrument Set for 3.5 mm Screws Titan/Titanium

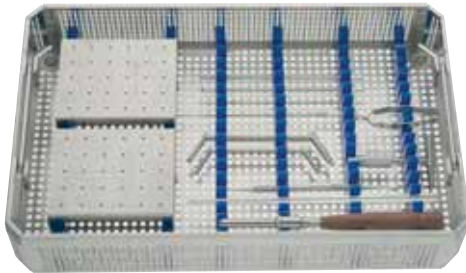

**15-1070**

Container 465 x 280 x 100 mm

**15-3068-1**

Sieb 405 x 255 x 70 mm

### Set contents of implants

Cat. No.:	Description	Quant. in Set
5-30000	Cannulated screw ø 3,5 mm / L 10 mm, short thread, self-tapping	3
5-30200	Cannulated screw ø 3,5 mm / L 12 mm, short thread, self-tapping	3
5-30400	Cannulated screw ø 3,5 mm / L 14 mm, short thread, self-tapping	3
5-30600	Cannulated screw ø 3,5 mm / L 16 mm, short thread, self-tapping	3
5-30800	Cannulated screw ø 3,5 mm / L 18 mm, short thread, self-tapping	3
5-31000	Cannulated screw ø 3,5 mm / L 20 mm, short thread, self-tapping	3
5-31200	Cannulated screw ø 3,5 mm / L 22 mm, short thread, self-tapping	3
5-31400	Cannulated screw ø 3,5 mm / L 24 mm, short thread, self-tapping	3
5-31600	Cannulated screw ø 3,5 mm / L 26 mm, short thread, self-tapping	3
5-31800	Cannulated screw ø 3,5 mm / L 28 mm, short thread, self-tapping	3
5-32000	Cannulated screw ø 3,5 mm / L 30 mm, short thread, self-tapping	3
5-32200	Cannulated screw ø 3,5 mm / L 32 mm, short thread, self-tapping	3
5-32400	Cannulated screw ø 3,5 mm / L 34 mm, short thread, self-tapping	3
5-32600	Cannulated screw ø 3,5 mm / L 36 mm, short thread, self-tapping	3
5-32800	Cannulated screw ø 3,5 mm / L 38 mm, short thread, self-tapping	3
5-33000	Cannulated screw ø 3,5 mm / L 40 mm, short thread, self-tapping	3
5-33200	Cannulated screw ø 3,5 mm / L 42 mm, short thread, self-tapping	3
5-33400	Cannulated screw ø 3,5 mm / L 44 mm, short thread, self-tapping	3
5-33600	Cannulated screw ø 3,5 mm / L 46 mm, short thread, self-tapping	3
5-33800	Cannulated screw ø 3,5 mm / L 48 mm, short thread, self-tapping	3
5-34000	Cannulated screw ø 3,5 mm / L 50 mm, short thread, self-tapping	3

Cat. No.:	Description	Quant. in Set
5-34200	Cannulated screw ø 3,5 mm / L 10 mm, fully threaded, self-tapping	3
5-34400	Cannulated screw ø 3,5 mm / L 12 mm, fully threaded, self-tapping	3
5-34600	Cannulated screw ø 3,5 mm / L 14 mm, fully threaded, self-tapping	3
5-34800	Cannulated screw ø 3,5 mm / L 16 mm, fully threaded, self-tapping	3
5-35000	Cannulated screw ø 3,5 mm / L 18 mm, fully threaded, self-tapping	3
5-35200	Cannulated screw ø 3,5 mm / L 20 mm, fully threaded, self-tapping	3
5-35400	Cannulated screw ø 3,5 mm / L 22 mm, fully threaded, self-tapping	3
5-35600	Cannulated screw ø 3,5 mm / L 24 mm, fully threaded, self-tapping	3
5-35800	Cannulated screw ø 3,5 mm / L 26 mm, fully threaded, self-tapping	3
5-36000	Cannulated screw ø 3,5 mm / L 28 mm, fully threaded, self-tapping	3
5-36200	Cannulated screw ø 3,5 mm / L 30 mm, fully threaded, self-tapping	3
5-36400	Cannulated screw ø 3,5 mm / L 32 mm, fully threaded, self-tapping	3
5-36600	Cannulated screw ø 3,5 mm / L 34 mm, fully threaded, self-tapping	3
5-36800	Cannulated screw ø 3,5 mm / L 36 mm, fully threaded, self-tapping	3
5-37000	Cannulated screw ø 3,5 mm / L 38 mm, fully threaded, self-tapping	3
5-37200	Cannulated screw ø 3,5 mm / L 40 mm, fully threaded, self-tapping	3
5-37400	Cannulated screw ø 3,5 mm / L 42 mm, fully threaded, self-tapping	3
5-37600	Cannulated screw ø 3,5 mm / L 44 mm, fully threaded, self-tapping	3
5-37800	Cannulated screw ø 3,5 mm / L 46 mm, fully threaded, self-tapping	3
5-38000	Cannulated screw ø 3,5 mm / L 48 mm, fully threaded, self-tapping	3
5-38200	Cannulated screw ø 3,5 mm / L 50 mm, fully threaded, self-tapping	3
4-17600	Washer 7,0 x 3,8 mm	5

9-334	Tap Sleeve 3,5 mm	
	Drill Sleeve 2,5 mm	1
9-168	Screw Driver Sleeve for 5-122	1
5-194	Tap for 3,5 mm cannulated Screws	1
5-188	Drill bit 3,5 mm / 1,4 mm cannulated	1
5-190	Drill bit 2,7 mm / 1,4 mm cannulated	1
9-093	Cannulated Tap Handle	1
5-126	Tap Sleeve 2,7 mm / Drill Sleeve 1,3 mm	1
5-184	Cannulated Counter sink	
	for 3,5 mm and 4,0 mm screws	1
5-122	Screw Driver f cannulated Screws	1
5-135	Guide Wire 1,2 x 150 mm	10

5-172	Direct Screw length Gauge for 3,5 mm	1
5-174	Canal Brush ø 1,35 mm	1
5-176	Canal cleaner ø 1,2 mm	1
4-184	Screw forceps	1
9-116	Sharp Hook	1
5-178	Holding Clamps	1
T 314	Rack for ø 3,5 mm screws	2



# TREU = INSTRUMENTE

## Cannulated Screws $\varnothing$ 3.5 mm



Stainless Steel

Dia of thread	3.5 mm	3.5 mm
Dia of core	2,5 mm	2,5 mm
Dia of shaft	2,5 mm	
Dia of head	5,0 mm	5,0 mm
Pitch	1,25 mm	1,25 mm
Cannulation	1,35 mm	1,35 mm
Length		
10 mm	<b>5-300</b>	<b>5-342</b>
12 mm	<b>5-302</b>	<b>5-344</b>
14 mm	<b>5-304</b>	<b>5-346</b>
16 mm	<b>5-306</b>	<b>5-348</b>
18 mm	<b>5-308</b>	<b>5-350</b>
20 mm	<b>5-310</b>	<b>5-352</b>
22 mm	<b>5-312</b>	<b>5-354</b>
24 mm	<b>5-314</b>	<b>5-356</b>
26 mm	<b>5-316</b>	<b>5-358</b>
28 mm	<b>5-318</b>	<b>5-360</b>
30 mm	<b>5-320</b>	<b>5-362</b>
32 mm	<b>5-322</b>	<b>5-364</b>
34 mm	<b>5-324</b>	<b>5-366</b>
36 mm	<b>5-326</b>	<b>5-368</b>
38 mm	<b>5-328</b>	<b>5-370</b>
40 mm	<b>5-330</b>	<b>5-372</b>
42 mm	<b>5-332</b>	<b>5-374</b>
44 mm	<b>5-334</b>	<b>5-376</b>
46 mm	<b>5-336</b>	<b>5-378</b>
48 mm	<b>5-338</b>	<b>5-380</b>
50 mm	<b>5-340</b>	<b>5-382</b>

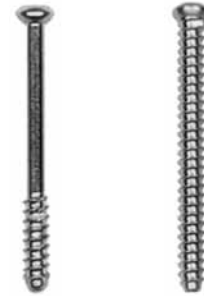

Titan/Titanium

Dia of thread	3.5 mm	3.5 mm
Dia of core	2,5 mm	2,5 mm
Dia of shaft	2,5 mm	
Dia of head	5,0 mm	5,0 mm
Pitch	1,25 mm	1,25 mm
Cannulation	1,35 mm	1,35 mm
Length		
10 mm	<b>5-30000</b>	<b>5-34200</b>
12 mm	<b>5-30200</b>	<b>5-34400</b>
14 mm	<b>5-30400</b>	<b>5-34600</b>
16 mm	<b>5-30600</b>	<b>5-34800</b>
18 mm	<b>5-30800</b>	<b>5-35000</b>
20 mm	<b>5-31000</b>	<b>5-35200</b>
22 mm	<b>5-31200</b>	<b>5-35400</b>
24 mm	<b>5-31400</b>	<b>5-35600</b>
26 mm	<b>5-31600</b>	<b>5-35800</b>
28 mm	<b>5-31800</b>	<b>5-36000</b>
30 mm	<b>5-32000</b>	<b>5-36200</b>
32 mm	<b>5-32200</b>	<b>5-36400</b>
34 mm	<b>5-32400</b>	<b>5-36600</b>
36 mm	<b>5-32600</b>	<b>5-36800</b>
38 mm	<b>5-32800</b>	<b>5-37000</b>
40 mm	<b>5-33000</b>	<b>5-37200</b>
42 mm	<b>5-33200</b>	<b>5-37400</b>
44 mm	<b>5-33400</b>	<b>5-37600</b>
46 mm	<b>5-33600</b>	<b>5-37800</b>
48 mm	<b>5-33800</b>	<b>5-38000</b>
50 mm	<b>5-34000</b>	<b>5-38200</b>

Guide Wire with 10 mm thread

**5-135** Guide Wire 1.2 mm  $\varnothing$  for Hollow Screws 3.5 mm  $\varnothing$  150 mm



**4-176** Stainless Steel  
**4-17600** Titan/Titanium  
 Washers  
 7,0 x 3,6 mm



# TREU - INSTRUMENTE

## Instruments for 3.5 mm Cannulated Screws

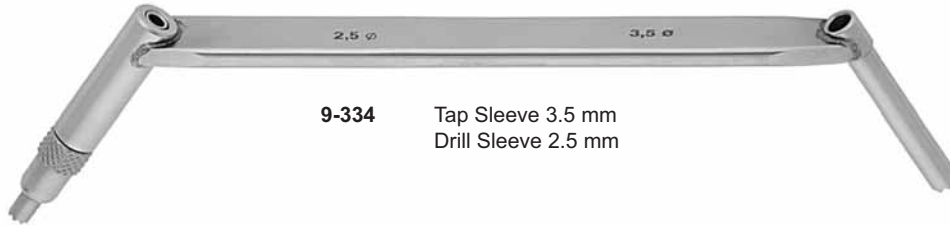

**9-334** Tap Sleeve 3.5 mm  
Drill Sleeve 2.5 mm



**9-168** Screwdriver Sleeve for 5-122



**5-122** Screw Driver for 3.5 mm and 4,0 mm cannulated screws 195 mm



**5-194** Tap for 3.5 mm cannulated screws 160 mm



**9-093** Tap Handle  
Cannulated



Cannulated Drill Bit 160 mm length

**5-188** Drill Bit  $\varnothing$  3.5 mm / 1.35 mm

**5-190** Drill Bit  $\varnothing$  2.7 mm / 1.35 mm



**5-126** Tap Sleeve 2.7 mm  
Drill Sleeve 1.0 mm



# TREU = INSTRUMENTE

## Instruments for 3.5 mm Cannulated Screws



**5-184** Cannulated Counter Sink for 3,5 mm and 4,0 mm screws



**4-184** Screw Forceps



**9-116** Sharp Hook  
for checking of fracture ends and  
for removing in grown tissue in screw heads



**5-172** Direct Screw Length Gauge for 3.5 mm ø + 4.0 mm ø



**5-174** Canal Brush 1.35 mm ø



**5-176** Canal Cleaner 1.2 mm ø

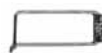

**5-178** Holding Clamp



**T 313** Rack for ø 3.5 mm 1.25 pitch screws



# TREU = INSTRUMENTE

## T 530 Cannulated Screws and Instrument Set for 4.0 mm Screws Stainless Steel

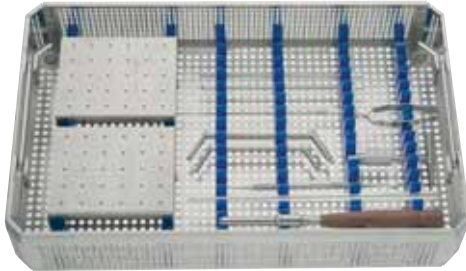

**15-1070**

Container 465 x 280 x 100 mm

**15-3068-1**

Sieb 405 x 255 x 70 mm

### Set contents of implants

Cat. No.:	Description	Quant. in Set
5-400	Cannulated screw ø 4,0 mm / L 10 mm, short thread, self-tapping	3
5-401	Cannulated screw ø 4,0 mm / L 12 mm, short thread, self-tapping	3
5-402	Cannulated screw ø 4,0 mm / L 14 mm, short thread, self-tapping	3
5-403	Cannulated screw ø 4,0 mm / L 16 mm, short thread, self-tapping	3
5-404	Cannulated screw ø 4,0 mm / L 18 mm, short thread, self-tapping	3
5-405	Cannulated screw ø 4,0 mm / L 20 mm, short thread, self-tapping	3
5-406	Cannulated screw ø 4,0 mm / L 22 mm, short thread, self-tapping	3
5-407	Cannulated screw ø 4,0 mm / L 24 mm, short thread, self-tapping	3
5-408	Cannulated screw ø 4,0 mm / L 26 mm, short thread, self-tapping	3
5-409	Cannulated screw ø 4,0 mm / L 28 mm, short thread, self-tapping	3
5-410	Cannulated screw ø 4,0 mm / L 30 mm, short thread, self-tapping	3
5-411	Cannulated screw ø 4,0 mm / L 32 mm, short thread, self-tapping	3
5-412	Cannulated screw ø 4,0 mm / L 34 mm, short thread, self-tapping	3

Cat. No.:	Description	Quant. in Set
5-413	Cannulated screw ø 4,0 mm / L 36 mm, short thread, self-tapping	3
5-414	Cannulated screw ø 4,0 mm / L 38 mm, short thread, self-tapping	3
5-415	Cannulated screw ø 4,0 mm / L 40 mm, short thread, self-tapping	3
5-416	Cannulated screw ø 4,0 mm / L 42 mm, short thread, self-tapping	3
5-417	Cannulated screw ø 4,0 mm / L 44 mm, short thread, self-tapping	3
5-418	Cannulated screw ø 4,0 mm / L 46 mm, short thread, self-tapping	3
5-419	Cannulated screw ø 4,0 mm / L 48 mm, short thread, self-tapping	3
5-420	Cannulated screw ø 4,0 mm / L 50 mm, short thread, self-tapping	3
3-520	Washer 11 x 4,8 mm	5

9-334	Tap Sleeve 3,5 mm	
	Drill Sleeve 2,5 mm	1
9-168	Screw Driver Sleeve for 5-122	1
5-193	Tap for 4,0 mm cannulated screws quick coupling	1
5-188	Drill Bit 3,5 / 1,4 mm cannulated	1
5-190	Drill Bit 2,7 mm / 1,4 mm cannulated	1
9-093	Cannulated Tap handle	1
5-126	Tap Sleeve 2,7 mm Drill sleeve 1,3 mm	1
5-184	Cannulated Counter sink for 3,5 and 4,0 mm screws	1
4-184	screw forceps	1
9-116	sharp hook	1
5-172	Direct screw length guage for 4,0 mm	1
5-174	Canal brush 1,35 mm	1
5-176	Canal cleaner 1,2 mm	1
5-178	Holding clamps	1
5-135	Guide Wire ø 1,2 mm x 150 mm	10
5-122	Screw Driver f. cannulated screws	1
T 315	Rack for ø 4,0 mm screws	2





# TREU = INSTRUMENTE

## T 532 Cannulated Screws and Instrument Set for 4.0 mm Screws Titan/Titanium

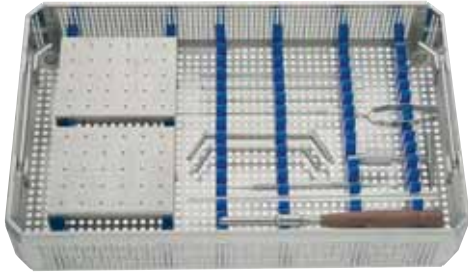

**15-1070**

Container 465 x 280 x 100 mm

**15-3068-1**

Sieb 405 x 255 x 70 mm

### Set contents of implants

Cat. No.:	Description	Quant. in Set
5-40000	Cannulated screw ø 4,0 mm / L 10 mm, short thread, self-tapping	3
5-40100	Cannulated screw ø 4,0 mm / L 12 mm, short thread, self-tapping	3
5-40200	Cannulated screw ø 4,0 mm / L 14 mm, short thread, self-tapping	3
5-40300	Cannulated screw ø 4,0 mm / L 16 mm, short thread, self-tapping	3
5-40400	Cannulated screw ø 4,0 mm / L 18 mm, short thread, self-tapping	3
5-40500	Cannulated screw ø 4,0 mm / L 20 mm, short thread, self-tapping	3
5-40600	Cannulated screw ø 4,0 mm / L 22 mm, short thread, self-tapping	3
5-40700	Cannulated screw ø 4,0 mm / L 24 mm, short thread, self-tapping	3
5-40800	Cannulated screw ø 4,0 mm / L 26 mm, short thread, self-tapping	3
5-40900	Cannulated screw ø 4,0 mm / L 28 mm, short thread, self-tapping	3
5-41000	Cannulated screw ø 4,0 mm / L 30 mm, short thread, self-tapping	3
5-41100	Cannulated screw ø 4,0 mm / L 32 mm, short thread, self-tapping	3
5-41200	Cannulated screw ø 4,0 mm / L 34 mm, short thread, self-tapping	3

Cat. No.:	Description	Quant. in Set
5-41300	Cannulated screw ø 4,0 mm / L 36 mm, short thread, self-tapping	3
5-41400	Cannulated screw ø 4,0 mm / L 38 mm, short thread, self-tapping	3
5-41500	Cannulated screw ø 4,0 mm / L 40 mm, short thread, self-tapping	3
5-41600	Cannulated screw ø 4,0 mm / L 42 mm, short thread, self-tapping	3
5-41700	Cannulated screw ø 4,0 mm / L 44 mm, short thread, self-tapping	3
5-41800	Cannulated screw ø 4,0 mm / L 46 mm, short thread, self-tapping	3
5-41900	Cannulated screw ø 4,0 mm / L 48 mm, short thread, self-tapping	3
5-42000	Cannulated screw ø 4,0 mm / L 50 mm, short thread, self-tapping	3
3-52000	Washer 11 x 4,8 mm	5

9-334	Tap Sleeve 3,5 mm	
	Drill Sleeve 2,5 mm	1
9-168	Screw Driver Sleeve for 5-122	1
5-193	Tap for 4,0 mm cannulated screws quick coupling	1
5-188	Drill Bit 3,5 / 1,4 mm cannulated	1
5-190	Drill Bit 2,7 mm / 1,4 mm cannulated	1
9-093	Cannulated Tap handle	1
5-126	Tap Sleeve 2,7 mm Drill sleeve 1,3 mm	1
5-184	Cannulated Counter sink for 3,5 and 4,0 mm screws	1
4-184	screw forceps	1
9-116	sharp hook	1
5-172	Direct screw length guage for 4,0 mm	1
5-174	Canal brush 1,35 mm	1
5-176	Canal cleaner 1,2 mm	1
5-178	Holding clamps	1
5-135	Guide Wire ø 1,2 mm x 150 mm	10
5-122	Screw Driver f. cannulated screws	1
T 315	Rack for ø 4,0 mm screws	2



# TREU = INSTRUMENTE

## Cannulated Screws $\varnothing$ 4.0 mm



Stainless Steel

Dia of thread	4.0 mm
Pitch	1,75 mm
Dia of core	2,5 mm
Dia of shaft	2,7 mm
Dia of head	5,0 mm
Cannulation	1,35 mm
Hexagon	2,5
Length	
10 mm	<b>5-400</b>
12 mm	<b>5-401</b>
14 mm	<b>5-402</b>
16 mm	<b>5-403</b>
18 mm	<b>5-404</b>
20 mm	<b>5-405</b>
22 mm	<b>5-406</b>
24 mm	<b>5-407</b>
26 mm	<b>5-408</b>
28 mm	<b>5-409</b>
30 mm	<b>5-410</b>
32 mm	<b>5-411</b>
34 mm	<b>5-412</b>
36 mm	<b>5-413</b>
38 mm	<b>5-414</b>
40 mm	<b>5-415</b>
42 mm	<b>5-416</b>
44 mm	<b>5-417</b>
46 mm	<b>5-418</b>
48 mm	<b>5-419</b>
50 mm	<b>5-420</b>



Titan/Titanium

Dia of thread	4.0 mm
Pitch	1,75 mm
Dia of core	2,5 mm
Dia of shaft	2,7 mm
Dia of head	5,0 mm
Cannulation	1,35 mm
Hexagon	2,5
Length	
10 mm	<b>5-40000</b>
12 mm	<b>5-40100</b>
14 mm	<b>5-40200</b>
16 mm	<b>5-40300</b>
18 mm	<b>5-40400</b>
20 mm	<b>5-40500</b>
22 mm	<b>5-40600</b>
24 mm	<b>5-40700</b>
26 mm	<b>5-40800</b>
28 mm	<b>5-40900</b>
30 mm	<b>5-41000</b>
32 mm	<b>5-41100</b>
34 mm	<b>5-41200</b>
36 mm	<b>5-41300</b>
38 mm	<b>5-41400</b>
40 mm	<b>5-41500</b>
42 mm	<b>5-41600</b>
44 mm	<b>5-41700</b>
46 mm	<b>5-41800</b>
48 mm	<b>5-41900</b>
50 mm	<b>5-42000</b>

Guide Wire with 10 mm thread

**5-135** Guide Wire 1.2 mm  $\varnothing$  for Hollow Screws  $\varnothing$  4,0 mm, 150 mm



**3-520** Stainless Steel  
**3-52000** Titan/Titanium  
 Washers  
 11,0 x 4,8 mm



# TREU - INSTRUMENTE

## Instruments for 4.0 mm Cannulated Screws

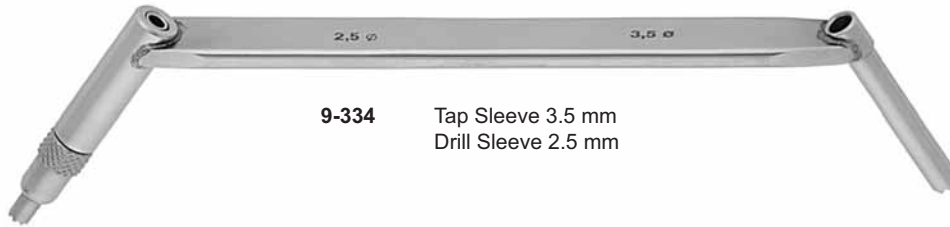

**9-334** Tap Sleeve 3.5 mm  
Drill Sleeve 2.5 mm



**9-168** Screwdriver Sleeve for 5-122



**5-122** Screw Driver for 3.5 / 4.0 mm cannulated screws 195 mm



**5-193** Tap for 4.0 mm cannulated screws AO 160 mm



**9-093** Tap Handle  
cannulated



**5-188** Cannulated Drill Bit 160 mm length  
Drill Bit  $\varnothing$  3.5 mm / 1.35 mm  
**5-190** Drill Bit  $\varnothing$  2.7 mm / 1.35 mm



**5-126** Tap Sleeve 2.7 mm  
Drill Sleeve 1.0 mm



# TREU = INSTRUMENTE

## Instruments for 4.0 mm Cannulated Screws



**5-184** Cannulated Counter Sink for 3,5 mm and 4,0 mm screws



**4-184** Screw Forceps



**9-116** Sharp Hook  
for checking of fracture ends and  
for removing in grown tissue in screw heads



**5-172** Direct Screw Length Gauge for 3.5 mm ø + 4.0 mm ø



**5-174** Canal Brush 1.35 mm ø



**5-176** Canal Cleaner 1.2 mm ø



**5-178** Holding Clamp



**T 315** Rack for ø 4.0 mm screws (half threaded)



# TREU = INSTRUMENTE

## Epiphyseal Staples Stainless Steel



**5-631**  
For conveytry



- 5-600** Barbed Staples 8.7 x 16 x 2 mm
- 5-602** Barbed Staples 8.7 x 19 x 2 mm
- 5-604** Barbed Staples 8.7 x 22 x 2 mm
- 5-606** Barbed Staples 8.7 x 25 x 2 mm



**5-610**  
24 x 33 x 4.8 mm



**5-612**  
24 x 33 x 9.5 mm



**5-614**  
24 x 33 x 14 mm



	Diameter	Width	Length
<b>5-620</b>	2.5 mm	22 mm	19 mm
<b>5-622</b>	2.5 mm	16 mm	19 mm
<b>5-624</b>	1.5 mm	22 mm	19 mm
<b>5-626</b>	1.5 mm	16 mm	19 mm

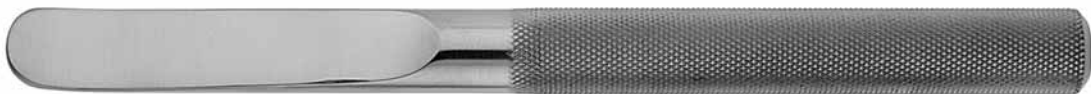

**5-630** Staples Extractor



**5-632** Staples Driver



**5-634** Staples Inserter for U-Staples



# TREU = INSTRUMENTE

## Staples



Chron Cobalt Molybden  
**5-650** 6 mm

Titan  
**5-65000** 6 mm



Chron Cobalt Molybden  
**5-652** 8 mm

Titan  
**5-65200** 8 mm



Chron Cobalt Molybden  
**5-654** 11 mm

Titan  
**5-65400** 11 mm



Chron Cobalt Molybden  
**5-656** 14 mm

Titan  
**5-65600** 14 mm



**1-1920**

Schlitzhammer mit Schlitzweite 14 mm  
Slotted Hammer - width of the slot 14 mm

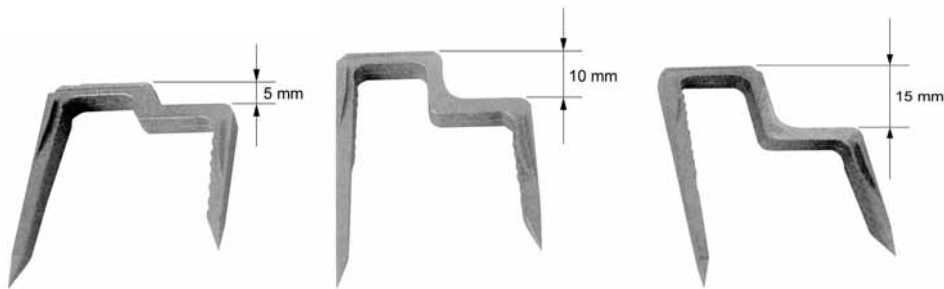

Chrom Cobalt Molybden			
Cat. No.:	Width	Length	Height
<b>5-730</b>	24 mm	40 mm	5 mm
<b>5-732</b>	24 mm	40 mm	10 mm
<b>5-734</b>	24 mm	40 mm	15 mm

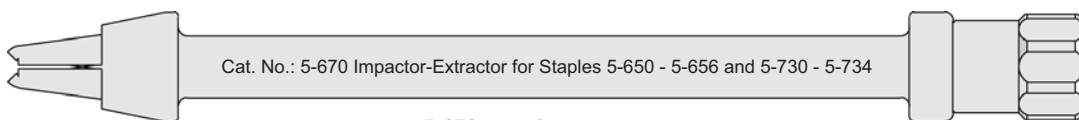

Cat. No.: 5-670 Impactor-Extractor for Staples 5-650 - 5-656 and 5-730 - 5-734

**5-670** Impactor



# TREU - INSTRUMENTE

## Chrome Cobalt Molybden Osteotomy Staples

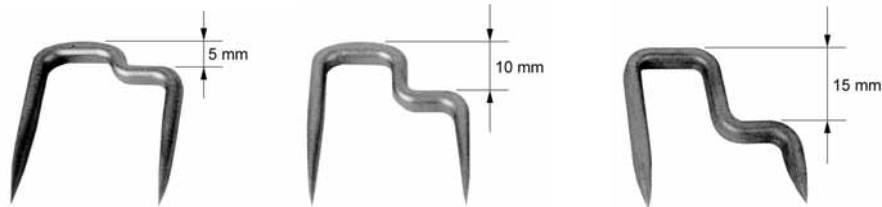

Cat. No.:	Width A	Length B	Height C
<b>5-710</b>	24 mm	30 mm	5 mm
<b>5-712</b>	24 mm	30 mm	10 mm
<b>5-714</b>	24 mm	30 mm	15 mm

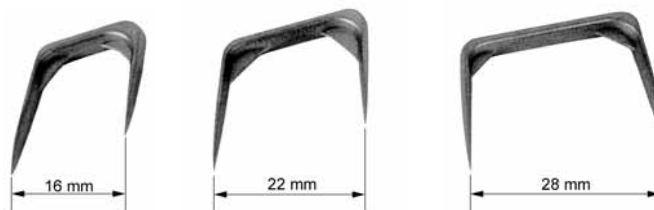
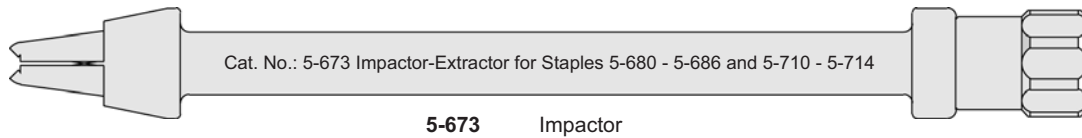

Cat. No.:	Width	Length
<b>5-705</b>	16 mm	22 mm
<b>5-706</b>	22 mm	22 mm
<b>5-707</b>	28 mm	22 mm

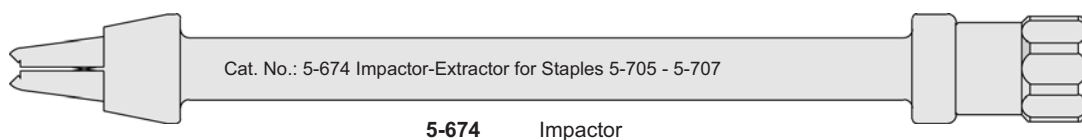



# TREU = INSTRUMENTE

Interferenzschrauben kannuliert  
Interference screws cannulated



Material: Titan ISO 5832 / 03

Total Length / mm	20	25	30
<b>Flat Head</b>			
ø 7 mm	<b>5-900</b>	<b>5-902</b>	<b>5-904</b>
ø 8 mm	<b>5-910</b>	<b>5-912</b>	<b>5-914</b>
ø 9 mm	<b>5-920</b>	<b>5-922</b>	<b>5-924</b>



Total Length / mm	20	25	30
<b>Round Head</b>			
ø 7 mm	<b>5-927</b>	<b>5-928</b>	<b>5-929</b>
ø 8 mm	<b>5-930</b>	<b>5-931</b>	<b>5-932</b>
ø 9 mm	<b>5-933</b>	<b>5-934</b>	<b>5-935</b>

Cannulated



<b>Cannulated Drill</b>	
5-950	ø 6.0 mm
5-952	ø 7.0 mm
5-954	ø 8.0 mm
5-956	ø 9.0 mm
5-958	ø 10.0 mm
5-960	ø 11.0 mm
5-962	ø 12.0 mm

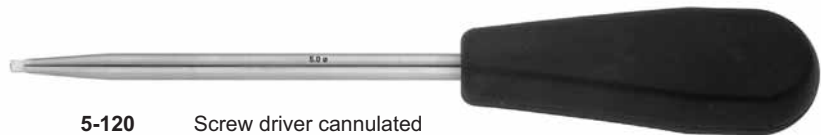

**5-120** Screw driver cannulated for interference screws

Interferenzschrauben, Schutzhülse  
Interference screws, Protective Sleeves



7.0 mm	8.0 mm	9.0 mm
<b>5-980</b>	<b>5-982</b>	<b>5-984</b>





# TREU = INSTRUMENTE

## Tendon Button

4 Loch / Holes  
4 x 12 mm



18-001



Suture Disk, ø 14 mm  
Reintitan  
Pure titanium  
18-030



18-040

Passierdraht ø 2,4 mm mit Öse und Spiralspitze Länge: 28 cm  
Passing Pin ø 2.4 mm with Eye and Drill Tip Length: 28 cm



Suture Disk, ø 14 mm  
mit Rotationssperre  
Reintitan  
with rotation fixation  
Pure titanium  
18-032



# TREU - INSTRUMENTE

---

**TREU INSTRUMENTE GMBH - INTERNATIONAL - TRAUMATOLOGY - ORTHOPAEDICS**  
**ALTENTALSTRASSE 6 - 10 · D-78532 TUTTLINGEN · TELEFON 0 74 61 / 9621-0**  
**TELEFAX 49 74 61 / 7 75 67 · INTERNET: [www.treu.com](http://www.treu.com)**

---