



YOUR RELIABLE PARTNER IN TRAUMA CARE

WE FOCUS THE FUTURE

EXTERNAL FIXATORS



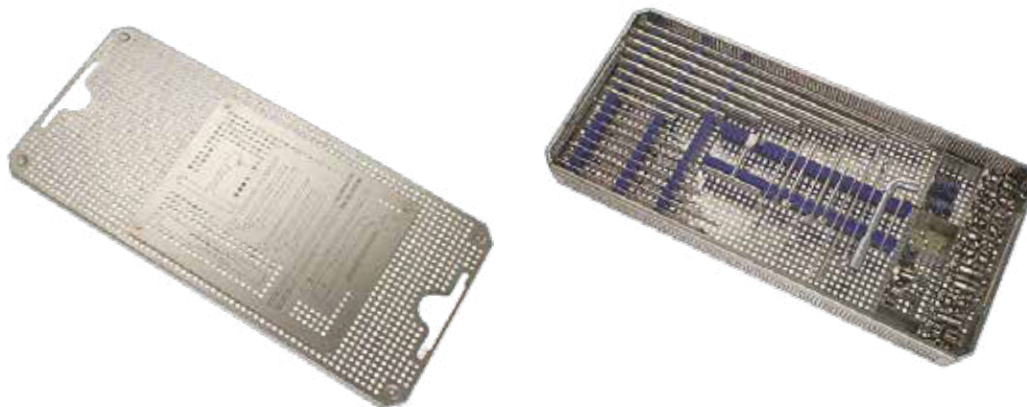

Set Cat. No. T 8000

 Standard External Fixator Set (Tubular System)
 Standard External Fixateursatz (Tubulares System)

Set Cat. No. T 8000

Cat. no. Art. Nr.	included items	QTY St.
T 8001	Tray for Standard External Fixator Set	1
9-023	Drill Bit AO Shaft Ø3.5mm, 195mm/170mm	2
9-1861	Combination Wrench 11.0mm	1
8-0068	Simple T-Handle for Steinmann Pins	1
1-1957	T-Wrench 11.0mm	1
8-0072	Hexagonal Allen Key 3.5mm	1
8-0092	Trocar with Point 3.5mm, 80mm length (short)	1
8-0061	Drill Sleeve 5.0mm/3.5mm, 80mm length	1
8-0065	Drill Sleeve 6.0mm/5.0mm, short	1
8-0062	Trocar for Aiming Device	1
8-0060	Drill Sleeve 5.0mm/3.5mm, 110mm length	1
8-0064	Drill Sleeve 6.0mm/5.0mm, long	1
8-0080	Open Compressor	2
8-0100	Tube Ø11.0mm, 100mm length	1
8-0102	Tube Ø11.0mm, 125mm length	1
8-0104	Tube Ø11.0mm, 150mm length	2
8-0106	Tube Ø11.0mm, 200mm length	2
8-0108	Tube Ø11.0mm, 250mm length	2
8-0110	Tube Ø11.0mm, 300mm length	2
8-0112	Tube Ø11.0mm, 350mm length	2
8-0114	Tube Ø11.0mm, 400mm length	2
8-0170	Plug for Tubes	10
8-0188	Open Clamp	12
8-0190	Tube to Tube Clamps 11.0mm	2
8-1264	Schanz Screw 5.0mm/125mm/50mm Thread	6
8-1266	Schanz Screw 5.0mm/150mm/50mm Thread	6
8-1268	Schanz Screw 5.0mm/170mm/50mm Thread	6
8-1270	Schanz Screw 5.0mm/200mm/50mm Thread	6



Cat. no. Art. Nr.	Ø	Length Länge	PU VPE
9-023	3.5mm	195mm / 170mm	1
9-027	4.5mm	195mm / 170mm	1

Drill Bit AO Shaft
Bohrer AO Schaft



Cat. no. Art. Nr.	Ø	Length Länge	PU VPE
9-1861	11.0mm	-	1

Combination Wrench 11.0mm
Ringmaulschlüssel 11.0mm



Cat. no. Art. Nr.	Ø	Length Länge	PU VPE
8-0068	11.0mm	-	1

Simple T-Handle for Steinmann Pins
Einfacher T-Griff für Steinmann Nägel

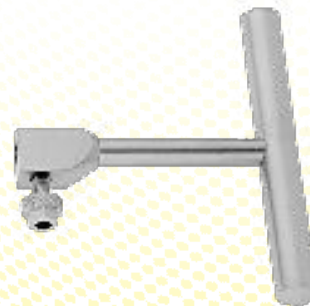

Cat. no. Art. Nr.	Ø	Length Länge	PU VPE
1-1957	11.0mm	-	1

T-Wrench 11.0mm
T-Schlüssel 11.0mm



Cat. no. Art. Nr.	Ø	Length Länge	PU VPE
8-0072	3.5mm	-	1

Hexagonal Allen Key 3.5mm
Hexagonaler Allenschlüssel 3.5mm





Cat. no. Art. Nr.	∅	Length Länge	PU VPE
8-0092	3.5mm	80mm	1

Trocar with Point 3.5mm, 80mm length (short)
Trokar mit Spitze 3.5mm, 80mm Länge (kurz)



Cat. no. Art. Nr.	∅	Length Länge	PU VPE
8-0061	5.0mm/3.5mm	80mm	1

Drill Sleeve 5.0mm/3.5mm, 80mm length
Führungshülse 5.0mm/3.5mm, 80mm Länge

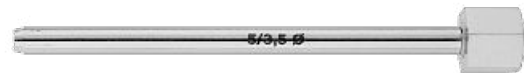

Cat. no. Art. Nr.	∅	Length Länge	PU VPE
8-0065	6.0mm/5.0mm	-	1

Drill Sleeve 6.0mm/5.0mm, short
Bohrbüchse 6.0mm/5.0mm, kurz



Cat. no. Art. Nr.	∅	Length Länge	PU VPE
8-0060	5.0mm/3.5mm	110mm	1

Drill Sleeve 5.0mm/3.5mm, 110mm length
Führungshülse 5.0mm/3.5mm, 110mm Länge



Cat. no. Art. Nr.	∅	Length Länge	PU VPE
8-0062	3.5mm	98.5mm	1

Trocar for Aiming Device
Trokar für Zielgerät



Cat. no. Art. Nr.	∅	Length Länge	PU VPE
8-0064	6.0mm/5.0mm	-	1

Drill Sleeve 6.0mm/5.0mm, long
Führungshülse 6.0mm/5.0mm, lang





Cat. no. Art. Nr.	∅	LxB	PU VPE
8-0080	-	45x30mm	1

Open Compressor
Offener Druckspanner



Cat. no. Art. Nr.	∅	Length Länge	PU VPE
8-0084	-	240mm	1

Bar with Hook and Sliding Drill Sleeve
Schiene mit Haken und Bohrbuchse



Cat. no. Art. Nr.	∅	Length Länge	PU VPE
8-0090	-	-	1

Check Tube for Device Alignment
Kontrollohr für Geräteausrichtung





Cat. no. Art. Nr.	Ø	Length Länge	PU VPE
8-0140	11.0mm	100mm	1
8-0142	11.0mm	125mm	1
8-0144	11.0mm	150mm	1
8-0146	11.0mm	200mm	1
8-0148	11.0mm	250mm	1
8-0150	11.0mm	300mm	1
8-0152	11.0mm	350mm	1
8-0154	11.0mm	400mm	1
8-0156	11.0mm	450mm	1
8-0158	11.0mm	500mm	1
8-0160	11.0mm	550mm	1
8-0162	11.0mm	600mm	1

Carbon Fiber Rods
Kohlefaserstange



Cat. no. Art. Nr.	Ø	Length Länge	PU VPE
8-0170	-	-	1

Plug for Tubes
Verschlussstopfen für Fixateurrohre



Cat. no. Art. Nr.	Ø	Length Länge	PU VPE
8-0180	-	-	1

Single adjustable Clamp
Backe schwenkbar



Cat. no. Art. Nr.	Ø	Length Länge	PU VPE
8-0182	-	-	1

Single open Clamp
Offene Backe





Cat. no. Art. Nr.	∅	Length Länge	PU VPE
8-0186	-	-	1

Universal Joint for two Tubes
Backe für zwei Rohre



Cat. no. Art. Nr.	∅	Length Länge	PU VPE
8-0188	-	-	1

Open Clamp
Offene Backe



Cat. no. Art. Nr.	∅	Length Länge	PU VPE
8-0190	-	-	1

Tube to Tube Clamps 11.0mm
Rohr-zu-Rohr Backe 11.0mm



Cat. no. Art. Nr.	∅	Length Länge	PU VPE
8-0194	-	-	1

Tube Nail Clamp
Rohr-Nagel-Klemme



Cat. no. Art. Nr.	∅	Length Länge	PU VPE
8-0198	-	-	1

Protective Caps for Steinmann Pins
Abdeckung für Steinmann Nägel





Set Cat. No. T 806

 Small External Fixateur for Hand and Forearm
 Set für kleinen externen Fixateur für Hand und Unterarm

Set Cat. No. T 806

Cat. no. Art. Nr.	included items	QTY St.
15-2054	Bottom non-perforated 300 x 140 x 100mm	1
15-2070	Lid perforated 300 x 140mm silver	1
15-2150	Tray Stainless Steel 268 x 123 x 30mm	2
15-3266-2-2	Standard Silicon Device	4
9-014	Drill Bit AO Shaft 2.0mm, 100mm/75mm length	2
9-016	Drill Bit AO Shaft 2.5mm, 100mm/85mm length	2
8-0934	Combination Wrench width 7.0mm	1
8-0246	Socket Wrench width across Flats 7.0mm	1
8-0248	Drill Sleeve complete	1
8-0210	Connecting Bars 4.0mm x 60mm	2
8-0215	Connecting Bars 4.0mm x 160mm	2
8-0216	Connecting Bars 4.0mm x 180mm	2
8-0217	Connecting Bars 4.0mm x 200mm	2
8-0211	Connecting Bars 4.0mm x 80mm	4
8-0212	Connecting Bars 4.0mm x 100mm	4
8-0213	Connecting Bars 4.0mm x 120mm	4
8-0214	Connecting Bars 4.0mm x 140mm	4
8-0240	Clamp Open 2.5mm-5.0mm	4
8-0242	Clamp 2.5mm/5.0mm	12
8-0256	Spingloaded Nut	2
8-0255	Schanz Screw Ø 4.0mm-100mm	4
7-260	Kirschner Wire round 1.6mm x 150mm	10
7-264	Kirschner Wire round 2.0mm x 150mm	10
7-315	Kirschner Wire with thread 2.5mm x 150mm	10



Cat. no. Art. Nr.	Ø	Length Länge	PU VPE
9-014	2.0mm	100mm/75mm	1
9-016	2.5mm	100mm/85mm	1

Drill Bit AO Shaft
Bohrer AO Schaft



Cat. no. Art. Nr.	Ø	Length Länge	PU VPE
8-0934	7.0mm	-	1

Combination Wrench width 7.0mm
Gabel-/ Ringschlüssel Weite 7.0mm



Cat. no. Art. Nr.	Ø	Length Länge	PU VPE
8-0248	-	-	1

Drill Sleeve complete
Bohrhülse komplett



Cat. no. Art. Nr.	Ø	Length Länge	PU VPE
8-0246	7.0mm	120mm	1

Socket Wrench width across Flats 7.0mm
Steckschlüssel-Schlüsselweite 7.0mm

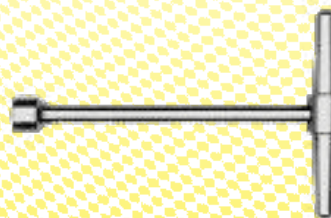

Cat. no. Art. Nr.	Ø	Length Länge	PU VPE
8-0250	5.0mm/4.0mm	-	1

Drill Sleeve 5.0mm/4.0mm
Bohrhülse 5.0mm/4.0mm





Cat. no. Art. Nr.	Ø	Length Länge	PU VPE
8-0251	4.0mm/2.7mm	-	1

Drill Sleeve 4.0mm/2.7mm
Bohrhülse 4.0mm/2.7mm



Cat. no. Art. Nr.	Ø	Length Länge	PU VPE
8-0252	2.7mm	-	1

Trocar Ø 2.7mm
Trokar Ø 2.7mm



Cat. no. Art. Nr.	Ø	Length Länge	PU VPE
8-0210	4.0mm	60mm	1
8-0211	4.0mm	80mm	1
8-0212	4.0mm	100mm	1
8-0213	4.0mm	120mm	1
8-0214	4.0mm	140mm	1
8-0215	4.0mm	160mm	1
8-0216	4.0mm	180mm	1
8-0217	4.0mm	200mm	1

Connecting Bars
Verbindungsstab



Cat. no. Art. Nr.	Ø	Length Länge	PU VPE
8-0240	2.5mm/5.0mm	-	1

Clamp Open 2.5mm/5.0mm
Klammer offen 2.5mm/5.0mm





Cat. no. Art. Nr.	Ø	Length Länge	PU VPE
8-0242	2.5mm/5.0mm	-	1

Clamp Ø 2.5mm/5.0mm
Klammer Ø 2.5mm/5.0mm



Cat. no. Art. Nr.	Ø	Length Länge	PU VPE
8-0254	4.0/3.0mm	80mm	1

Schanz Screw Ø 4.0/3.0mm, 80mm length
Schanzschraube Ø 4.0/3.0mm, 80mm Länge



Cat. no. Art. Nr.	Ø	Length Länge	PU VPE
8-0255	4.0mm	100mm	1

Schanz Screw Ø 4.0, 100mm length
Schanzschraube Ø 4.0mm, 100mm Länge



Cat. no. Art. Nr.	Ø	Length Länge	PU VPE
8-0256	-	-	1

Springloaded Nut
Federmutter





Cat. no. Art. Nr.	Type Typ	Length Länge	PU VPE
8-0404	short	230mm	1
8-0402	standard	250mm	1
8-0400	long	280mm	1

External Fixator ORTHO DYNO FIX for Femur and Tibia Fixateur externe ORTHO DYNO FIX für Femur und Tibia

Type short weight • Gewicht Typ short 600g
Type standard weight • Gewicht Typ standard 640g
Type long weight • Gewicht Typ long 700g

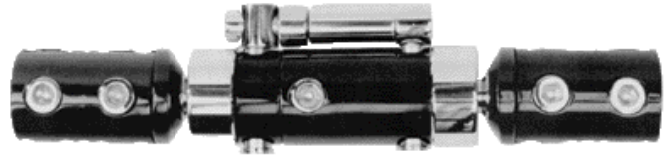

Cat. no. Art. Nr.	Ø	Length Länge	PU VPE
8-0406	-	-	1

Clamp 135° Fixierbacke 135°



Cat. no. Art. Nr.	Ø	Length Länge	PU VPE
8-0408	-	-	1

T-Clamp T-Backe





Cat. no. Art. Nr.	Type Typ	Length Länge	PU VPE
8-0412	standard	250mm	1

TREU Dynamic Axial Fixateur
TREU dynamic axial Fixateur

Type standard weight • Gewicht Typ standard 640g



Cat. no. Art. Nr.	Type Typ	Length Länge	PU VPE
8-0430	long	230mm	1
8-0432	standard	200mm	1
8-0434	short	180mm	1

TREU Limb Lengthener Fixateur
TREU Limb Lengthener Fixateur

Type short weight • Gewicht Typ short 420g
Type standard weight • Gewicht Typ standard 480g
Type long weight • Gewicht Typ long 540g

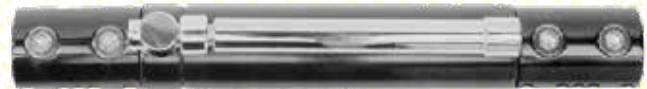



Cat. no. Art. Nr.	Type Typ	Length Länge	PU VPE
8-0440	short	200mm	1
8-0442	standard	250mm	1
8-0444	long	300mm	1

TREU Limb Reconstruction Fixateur
TREU Limb Fixateur für Rekonstruktion

Type short weight • Gewicht Typ short 410g
Type standard weight • Gewicht Typ standard 480g
Type long weight • Gewicht Typ long 560g

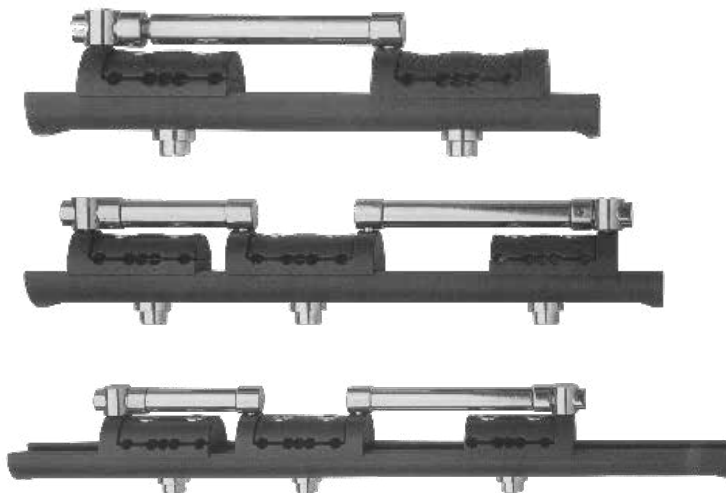

Cat. no. Art. Nr.	Type Typ	Length Länge	PU VPE
8-0450	short	-	1
8-0452	standard	-	1
8-0454	long	-	1

External Fixateur for Pelvic
Externer Fixateur für Becken

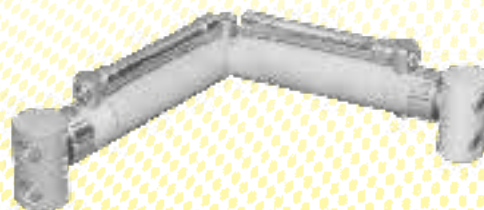

Cat. no. Art. Nr.	Type Typ	Length Länge	PU VPE
8-0460	short	-	1
8-0462	standard	-	1
8-0464	long	-	1

Rod and Clamp Fixateur multipurpose
Mehrzweckfixateur





Cat. no. Art. Nr.	Type Typ	Length Länge	PU VPE
8-0470	standard	170mm	1
8-0472	long	195mm	1

Dynamic axial Fixateur 45° Dynamic axial Fixateur 45°

Type standard weight • Gewicht Typ standard 300g
Type long weight • Gewicht Typ long 340g

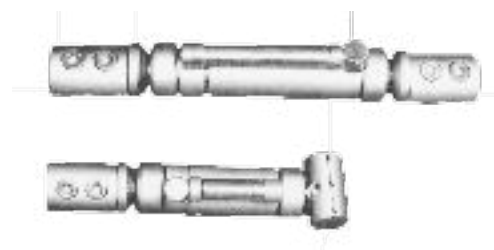

Cat. no. Art. Nr.	∅	LxB	PU VPE
8-0474	-	35 x 40mm	1

T-Clamp T-Backe



Cat. no. Art. Nr.	Type Typ	Length Länge	PU VPE
8-0482	long	230mm	1
8-0484	standard	190mm	1

External Fixator for Hand Fixateur extern für Hand





Cat. no. Art. Nr.	Ø	Length Länge	PU VPE
8-0300	-	-	1

TREU dynamic Fixteur externe large Type (Titanium)
TREU Dynamic Fixateur grosses Modell (Titan)



Cat. no. Art. Nr.	Ø	Length Länge	PU VPE
8-0330	-	110mm	1

Open End Wrench for TREU Fixateur 8-0300
Maulschlüssel für TREU Fixateur 8-0300



Cat. no. Art. Nr.	Ø	Length Länge	PU VPE
8-0338	-	-	1

Allen Key 5.0mm for TREU Fixateur 8-0300
Imbusschlüssel 5.0mm für TREU Fixateur 8-0300



Cat. no. Art. Nr.	Ø	Length Länge	PU VPE
8-0350	6.0/5.0mm	98mm	1

Drill Sleeve 6/5mm for TREU Fixateur 8-0300
Bohrbuchse 6/5mm für TREU Fixateur 8-0300



Cat. no. Art. Nr.	Ø	Length Länge	PU VPE
8-0360	-	112mm	1

Trocar for Drill Sleeve 6/5mm
Trokar für Bohrbuchse 6/5mm



Cat. no. Art. Nr.	Ø	Length Länge	PU VPE
8-0302	-	-	1

TREU dynamic Fixteur externe medium Type (Titanium)
TREU Dynamic Fixateur mittleres Modell (Titan)



Cat. no. Art. Nr.	Ø	Length Länge	PU VPE
8-0332	-	110mm	1

Open End Wrench for TREU Fixateur 8-0302
Maulschlüssel für TREU Fixateur 8-0302

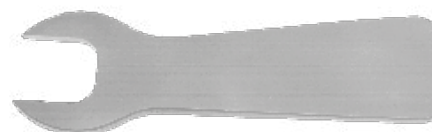

Cat. no. Art. Nr.	Ø	Length Länge	PU VPE
8-0338	-	-	1

Allen Key 5.0mm for TREU Fixateur 8-0302
Imbusschlüssel 5.0mm für TREU Fixateur 8-0302



Cat. no. Art. Nr.	Ø	Length Länge	PU VPE
8-0340	-	-	1

Allen Key 2.5mm for TREU Fixateur 8-0302
Imbusschlüssel 2.5mm für TREU Fixateur 8-0302



Cat. no. Art. Nr.	Ø	Length Länge	PU VPE
8-0352	-	60mm	1

Drill Sleeve 5/4mm for TREU Fixateur 8-0302
Bohrbuchse 5/4mm für TREU Fixateur 8-0302



Cat. no. Art. Nr.	Ø	Length Länge	PU VPE
8-0362	-	70.6mm	1

Trocar for Drill Sleeve 5/4mm
Trokar für Bohrbuchse mm





Cat. no. Art. Nr.	∅	Length Länge	PU VPE
8-0304	-	-	1

Dynamic Fixteur externe small Type (Titanium)
Dynamic Fixateur kleines Modell (Titan)



Cat. no. Art. Nr.	∅	Length Länge	PU VPE
8-0334	-	110mm	1

Open End Wrench for Fixateur 8-0304
Maulschlüssel für Fixateur 8-0304



Cat. no. Art. Nr.	∅	Length Länge	PU VPE
8-0338	-	-	1

Allen Key 5.0mm for Fixateur 8-0304
Imbusschlüssel 5.0mm für Fixateur 8-0304



Cat. no. Art. Nr.	∅	Length Länge	PU VPE
8-0342	-	-	1

Allen Key 1.5mm for Fixateur 8-0304
Imbusschlüssel 1.5mm für Fixateur 8-0304



Cat. no. Art. Nr.	∅	Length Länge	PU VPE
8-0354	-	40mm	1

Drill Sleeve 4/3mm for TREU Fixateur 8-0304
Bohrbuchse 4/3mm für TREU Fixateur 8-0304



Cat. no. Art. Nr.	∅	Length Länge	PU VPE
8-0364	-	48mm	1

Trocar for Drill Sleeve 4/3mm
Trokar für Bohrbuchse 4/3mm





Cat. no. Art. Nr.	∅	Length Länge	PU VPE
8-0312	-	-	1

Distractor for Fixateur externe
Distraktor für Fixateur



Cat. no. Art. Nr.	∅	Length Länge	PU VPE
8-0320	-	-	1

T-Jaw
T-Backe



Cat. no. Art. Nr.	∅	Length Länge	PU VPE
8-0339	-	-	1

Allen Key 4.0mm for T-Jaw 8-0320
Imbusschlüssel 4.0mm für T-Backe 8-0320



Cat. no. Art. Nr.	∅	Length Länge	PU VPE
8-0370	-	-	1

Socket Wrench for TREU Fixateur externe and Distractor
Kardanschlüssel für TREU Fixateure und Distraktor

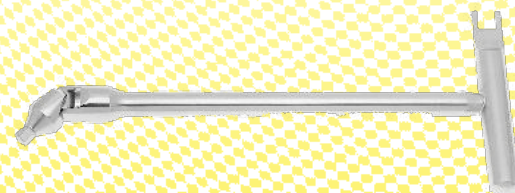

Cat. no. Art. Nr.	∅	Length Länge	PU VPE
8-0374	-	300mm	1

Depth Gauge for Schanz Screw
Tiefenmesser für Schanz-Schraube

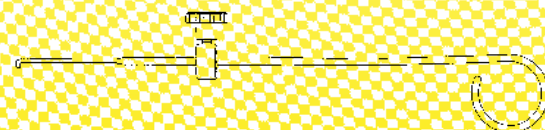



Set Cat. No. T 250

 Finger and Maxillo Facial Fixateur Set
 Finger- und Kiefer Fixateur Set

Set Cat. No. T 250

Cat. no. Art. Nr.	included items	QTY St.
8-2506	TREU-FIX No.1 Fixateur	1
8-2510	TREU-FIX No.2 Fixateur	1
8-2520	TREU-FIX No.3 Fixateur	1
T 251	Instrument Box plastic	1
8-2530	Threaded Rod 40mm	1
8-2532	Threaded Rod 50mm	1
8-2534	Threaded Rod 60mm	1
8-2526	Fixation Screw	20
8-2540	Screwdriver	1
8-2550	Holding Lever small	1
8-2552	Holding Lever wide	1
7-300	Kirschner Wire with Thread+Trocar 1.8mm, 70mm	12
7-301	Kirschner Wire with Thread+Trocar 1.6mm, 70mm	12
8-0342	Allen Key 1.5mm for Fixateur 8-0304	1
8-03391	Allen Key 4.0mm short	1



Cat. no. Art. Nr.	∅	Length Länge	PU VPE
8-2506	-	-	1

TREU-FIX No.1 Fixateur
TREU-FIX Nr.1 Fixateur



Cat. no. Art. Nr.	∅	Length Länge	PU VPE
8-2510	-	-	1

TREU-FIX No.2 Fixateur
TREU-FIX Nr.2 Fixateur



Cat. no. Art. Nr.	∅	Length Länge	PU VPE
8-2520	-	-	1

TREU-FIX No.3 Fixateur
TREU-FIX Nr.3 Fixateur



Cat. no. Art. Nr.	∅	Length Länge	PU VPE
8-2530	-	40mm	1
8-2532	-	50mm	1
8-2534	-	60mm	1

Threaded Rod
Ersatzspindel

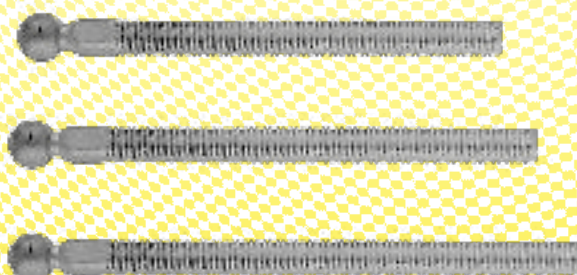



Cat. no. Art. Nr.	Ø	Length Länge	PU VPE
8-2540	-	-	1

Screwdriver
Schraubendreher



Cat. no. Art. Nr.	Ø	Length Länge	PU VPE
8-2550	-	-	1

Holding Lever small
Haltebolzen schmall



Cat. no. Art. Nr.	Ø	Length Länge	PU VPE
8-2552	-	-	1

Holding Lever wide
Haltebolzen breit



Cat. no. Art. Nr.	Ø	Length Länge	PU VPE
8-2560	-	-	1

Holding Forceps
Haltezange

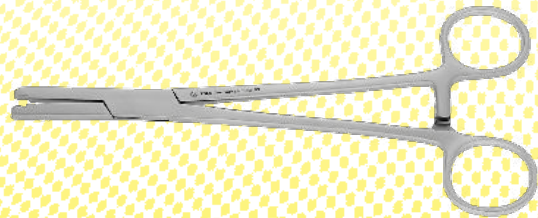

Cat. no. Art. Nr.	Ø	Length Länge	PU VPE
7-300	1.8mm	70mm	1
7-301	1.6mm	70mm	1

Kirschner Wire with Thread and Trocar, 70mm length
Kirschnerdraht mit Gewinde und Trokar, 70mm Länge





Cat. no. Art. Nr.	∅	Length Länge	PU VPE
7-430	-	180mm	1

TC Wire Cutter 180mm TC Drahtschneidezange 180mm

Soft wire • weicher Draht
Hard wire • harter Draht

2.0mm
1.5mm

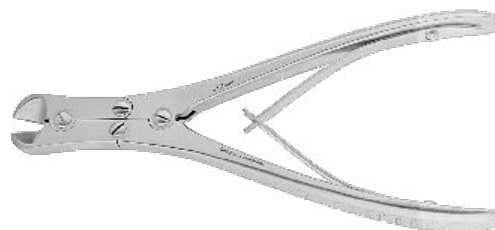

Cat. no. Art. Nr.	∅	Length Länge	PU VPE
7-432	-	180mm	1

TC Front- and Side Cutter 180mm TC Front- und Seitenschneider 180mm

Soft wire • weicher Draht
Hard wire • harter Draht

2.0mm
1.5mm

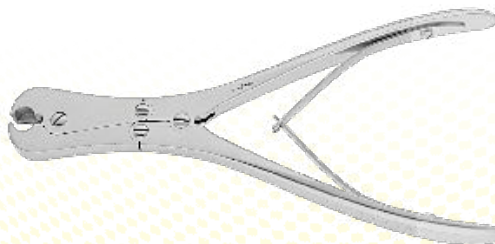

Cat. no. Art. Nr.	∅	Length Länge	PU VPE
7-388	-	130mm	1
7-390	-	180mm	1

Extraction Plier for Wires Extraktionszange für Bohrdrähte

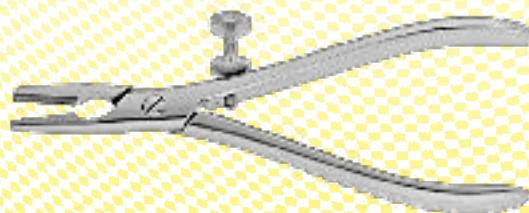

Cat. no. Art. Nr.	∅	Length Länge	PU VPE
7-402	-	180mm	1

Flat-Nose Plier 180mm Parallelfachzange 180mm





Cat. no. Art. Nr.	Ø	Length Länge	PU VPE
8-0345	6mm	-	1

 L-Wrench
L-Schlüssel

Cat. no. Art. Nr.	Ø	Length Länge	PU VPE
8-0786	-	-	1

 Combination Spanner width AA 10mm
Schraubenschlüssel AA 10mm

Cat. no. Art. Nr.	Ø	Length Länge	PU VPE
8-0070	-	180mm	1

 Socket Wrench SW11
Kardanschlüssel SW11





Cat. no. Art. Nr.	∅	Length Länge	PU VPE
9-090	-	-	1

T-Handle with quick action Chuck
T-Griff mit Schnellspannfutter

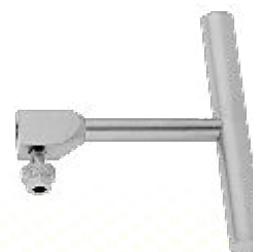

Cat. no. Art. Nr.	∅	Length Länge	PU VPE
8-0068	-	-	1

Simple T-Handle for Steinmann Pins insertion
Einfacher T-Griff für Steinmann Nägel



Cat. no. Art. Nr.	∅	Length Länge	PU VPE
8-0940	-	-	1

Wire Tightener
Drahtspanner

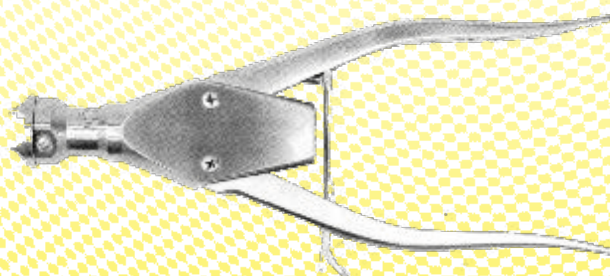



Cat. no. Art. Nr.	Ø	Length Länge	PU VPE
8-1100	3.5mm	120mm	1
8-1102	3.5mm	150mm	1
8-1104	3.5mm	180mm	1
8-1106	3.5mm	200mm	1
8-1108	3.5mm	250mm	1
8-1110	3.5mm	300mm	1
8-1112	4.0mm	120mm	1
8-1114	4.0mm	150mm	1
8-1116	4.0mm	180mm	1
8-1118	4.0mm	200mm	1
8-1120	4.0mm	250mm	1
8-1122	4.0mm	300mm	1
8-1124	4.5mm	120mm	1
8-1126	4.5mm	150mm	1
8-1128	4.5mm	180mm	1
8-1130	4.5mm	200mm	1
8-1132	4.5mm	250mm	1
8-1134	4.5mm	300mm	1
8-1136	5.0mm	120mm	1
8-1138	5.0mm	150mm	1
8-1140	5.0mm	180mm	1
8-1142	5.0mm	200mm	1
8-1144	5.0mm	250mm	1
8-1146	5.0mm	300mm	1

Steinmann Pin Trocar point Triangular Shaft Steinmann Nagel mit Trokar und Dreikantschaft



Other sizes on request
Weitere Größen auf Anfrage



Cat. no. Art. Nr.	Ø	Length Länge	PU VPE
8-1147	3.0mm	-	1
8-1148	4.0mm	-	1
8-1149	5.0mm	-	1

Protective Caps for Steinmann Pins Abdeckkappe für Steinmann Nägel





Cat. no. Art. Nr.	Ø	Length Länge	PU VPE
8-1150	3.0mm	150mm	1
8-1151	3.0mm	180mm	1
8-1152	3.0mm	200mm	1
8-1153	3.0mm	230mm	1
8-1154	3.5mm	150mm	1
8-1155	3.5mm	180mm	1
8-1156	3.5mm	200mm	1
8-1157	3.5mm	230mm	1
8-1158	4.0mm	150mm	1
8-1159	4.0mm	180mm	1
8-1160	4.0mm	200mm	1
8-1161	4.0mm	230mm	1
8-1162	4.0mm	250mm	1
8-1163	4.5mm	150mm	1
8-1164	4.5mm	180mm	1
8-1165	4.5mm	200mm	1
8-1166	4.5mm	230mm	1
8-1167	4.5mm	250mm	1
8-1168	4.5mm	300mm	1
8-1169	5.0mm	150mm	1
8-1170	5.0mm	180mm	1
8-1171	5.0mm	200mm	1
8-1172	5.0mm	230mm	1
8-1173	5.0mm	250mm	1
8-1174	5.0mm	300mm	1

Steinmann Pin with central Thread – Trocar and Triangular Shaft Steinmann Nagel mit Mittelgewinde – Trokar und Dreikantschaft



Other sizes on request
Weitere Größen auf Anfrage



Cat. no. Art. Nr.	Ø	Length/thread length Länge/Gewindelänge	PU VPE
8-1200	3.0mm	60mm / 20mm	1
8-1202	3.0mm	80mm / 20mm	1
8-1220	4.0mm	60mm / 25mm	1
8-1222	4.0mm	100mm / 25mm	1
8-1224	4.0mm	130mm / 25mm	1
8-1228	4.0mm	170mm / 25mm	1
8-1240	4.5mm	100mm / 50mm	1
8-1242	4.5mm	120mm / 50mm	1
8-1244	4.5mm	150mm / 50mm	1
8-1246	4.5mm	170mm / 50mm	1
8-1248	4.5mm	200mm / 50mm	1
8-1250	4.5mm	250mm / 50mm	1
8-1260	5.0mm	100mm / 50mm	1
8-1264	5.0mm	125mm / 50mm	1
8-1266	5.0mm	150mm / 50mm	1
8-1268	5.0mm	170mm / 50mm	1
8-1270	5.0mm	200mm / 50mm	1
8-1272	5.0mm	250mm / 50mm	1
8-1280	6.0mm	100mm / 30mm	1
8-1284	6.0mm	150mm / 50mm	1
8-1285	6.0mm	170mm / 50mm	1
8-1286	6.0mm	200mm / 50mm	1
8-1287	6.0mm	250mm / 50mm	1

Schanz Screw with Trocar and Triangular Shaft
Schanzschraube mit Trokar und Dreikantschaft



Other sizes on request
Weitere Größen auf Anfrage



Cat. no. Art. Nr.	Ø	Length/thread length Länge/Gewindelänge	PU VPE
8-1300	3.0mm	60mm / 20mm	1
8-1302	3.0mm	80mm / 20mm	1
8-1310	5.0mm	150mm / 50mm	1
8-1312	5.0mm	170mm / 50mm	1
8-1314	5.0mm	200mm / 50mm	1
8-1320	6.0mm	150mm / 50	1
8-1322	6.0mm	170mm / 50mm	1
8-1324	6.0mm	200mm / 50mm	1

Dynamic Screw
Dynamikschraube

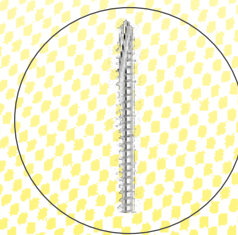

self drilling and self cutting
selbstbohrend und selbstschneidend

Other sizes on request
Weitere Größen auf Anfrage



Cat. no. Art. Nr.	thread length Gewindelänge	Length Länge	PU VPE
8-1350	30mm	90mm	1
8-1352	30mm	100mm	1
8-1356	40mm	100mm	1
8-1358	40mm	110mm	1
8-1360	40mm	120mm	1
8-1362	40mm	130mm	1
8-1370	50mm	110mm	1
8-1372	50mm	130mm	1
8-1374	50mm	140mm	1
8-1380	60mm	120mm	1
8-1382	60mm	130mm	1
8-1384	60mm	150mm	1
8-1390	70mm	160mm	1
8-1396	80mm	170mm	1
8-1398	80mm	200mm	1
8-1400	90mm	160mm	1
8-1402	90mm	180mm	1
8-1404	90mm	200mm	1
8-1410	100mm	200mm	1

Cortical Screw Kortikalisschraube

Screw Diameter • Schraubendurchmesser	6.50mm
Shaft Diameter • Schaftdurchmesser	6.00mm
Drill bit for threaded hole • Bohrer für Kernloch	4.80mm



Other sizes on request
Weitere Größen auf Anfrage



Cat. no. Art. Nr.	thread length Gewindelänge	Länge Länge	PU VPE
8-1450	30mm	90mm	1
8-1452	30mm	100mm	1
8-1456	40mm	100mm	1
8-1458	40mm	110mm	1
8-1460	40mm	120mm	1
8-1462	40mm	130mm	1
8-1464	50mm	110mm	1
8-1466	50mm	130mm	1
8-1468	50mm	150mm	1
8-1470	60mm	120mm	1
8-1472	60mm	130mm	1
8-1474	60mm	150mm	1

Cancellous Screw Spongiaschraube

Screw Diameter • Schraubendurchmesser	6.50mm
Shaft Diameter • Schaftdurchmesser	6.00mm
Drill bit for threaded hole • Bohrer für Kernloch	4.80mm



Other sizes on request
Weitere Größen auf Anfrage



Cat. no. Art. Nr.	Ø	Length/thread length Länge/Gewindelänge	PU VPE
8-1500	3.0mm	75mm / 25mm	1
8-1502	3.0mm	110mm / 22mm	1
8-1504	4.0mm	120mm / 45mm	1
8-1506	5.0mm	120mm / 40mm	1
8-1508	5.0mm	150mm / 50mm	1
8-1510	5.0mm	180mm / 50mm	1
8-1512	6.0mm	150mm / 50mm	1
8-1514	6.0mm	180mm / 50mm	1
8-1516	6.0mm	200mm / 60mm	1

Schanz Screw Triangular Shaft and self cutting
Schanzschraube Dreikantschaft und selbstschneidend



Other sizes on request
Weitere Größen auf Anfrage



Cat. no. Art. Nr.	Ø	Length Länge	PU VPE
8-1600	2.0mm	230mm	1
8-1602	2.5mm	230mm	1
8-1604	3.0mm	230mm	1
8-1606	3.5mm	230mm	1
8-1608	4.0mm	230mm	1
8-1610	4.5mm	230mm	1
8-1612	5.0mm	230mm	1

Steinmann Pin full Thread 230mm
Steinmann Nagel Vollgewinde 230mm



Other sizes on request
Weitere Größen auf Anfrage



Cat. no. Art. Nr.	Ø	Length Länge	PU VPE
8-1620	2.0mm	230mm	1
8-1622	2.5mm	230mm	1
8-1624	3.0mm	230mm	1
8-1626	3.5mm	230mm	1
8-1628	4.0mm	230mm	1
8-1630	4.5mm	230mm	1
8-1632	5.0mm	230mm	1

Steinmann Pin calibrated 230mm
Steinmann Nagel kalibriert 230mm



Other sizes on request
Weitere Größen auf Anfrage



Cat. no. Art. Nr.	Ø	Length Länge	PU VPE
9-014	2.0mm	100mm / 75mm	1
9-016	2.5mm	110mm / 85mm	1
9-018	2.7mm	100mm / 75mm	1
9-020	3.2mm	145mm / 120mm	1
9-021	3.2mm	195mm / 175mm	1
9-030	4.8mm	195mm / 170mm	1

Drill Bit AO Shaft
Bohrer AO Schaft



Cat. no. Art. Nr.	Ø	Length Länge	PU VPE
9-044	2.0mm	85mm / 70mm	1
9-046	2.5mm	95mm / 80mm	1
9-048	2.7mm	85mm / 70mm	1
9-050	3.2mm	130mm / 115mm	1
9-051	3.2mm	180mm / 165mm	1
9-054	4.8mm	180mm / 165mm	1

Drill Bit round Shaft
Bohrer runder Schaft



Cat. no. Art. Nr.	Ø	Length Länge	PU VPE
1-1861	3.5mm	150mm	1
1-1862	4.0mm	150mm	1
1-1863	4.8mm	150mm	1

Drill Bit cannulated Hole Ø 2.1mm
Kanülierter Bohrer Bohrung Ø 2.1mm





TREU-Instrumente GmbH
take-off Gewerbepark 130-132
78579 Neuhausen ob Eck
Germany

Phone +49 (0) 74 67/947 673 0
Fax +49 (0) 74 67/947 673 50

www.treu.com
info@treu.com