

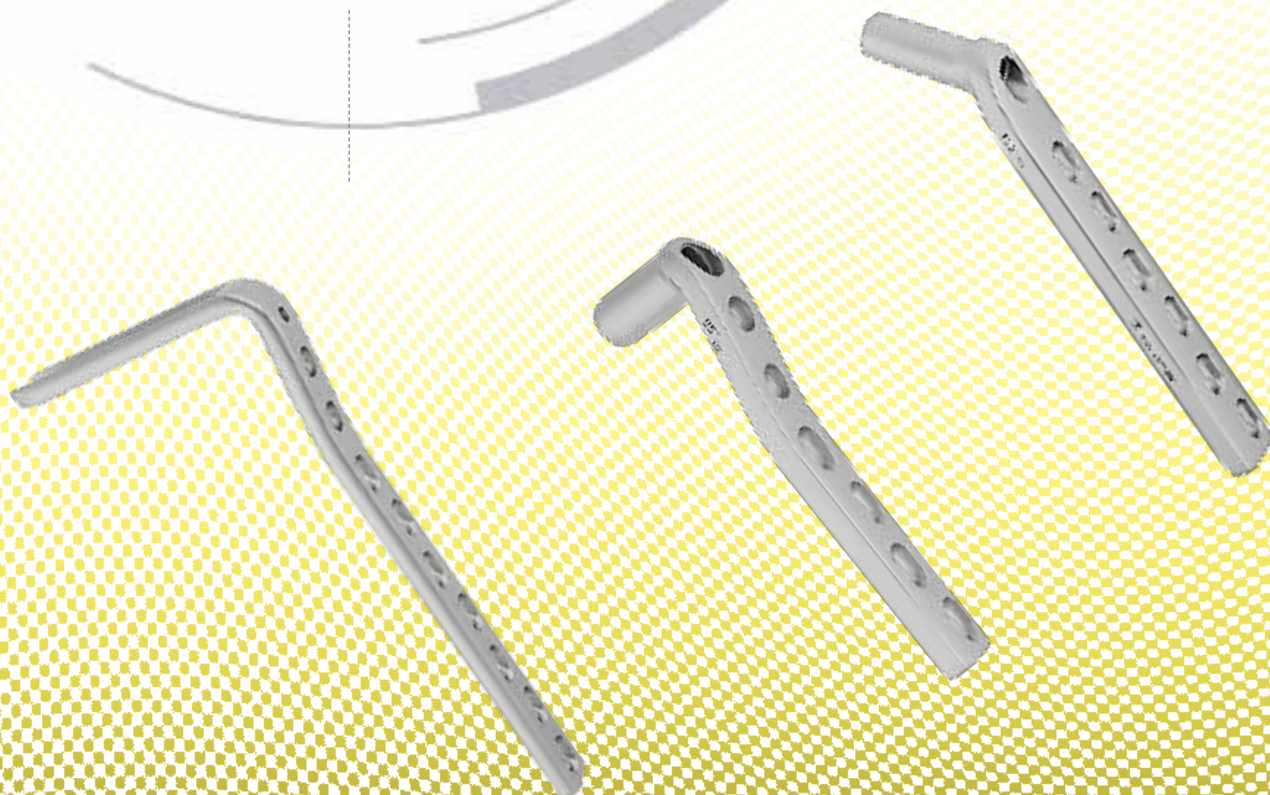

YOUR RELIABLE PARTNER IN TRAUMA CARE

WE FOCUS THE FUTURE

Hip Nails and Angled Plates





Set Cat. No. T 200

Instrument Set for Angled Plate
Instrumentensatz für Winkelplatten

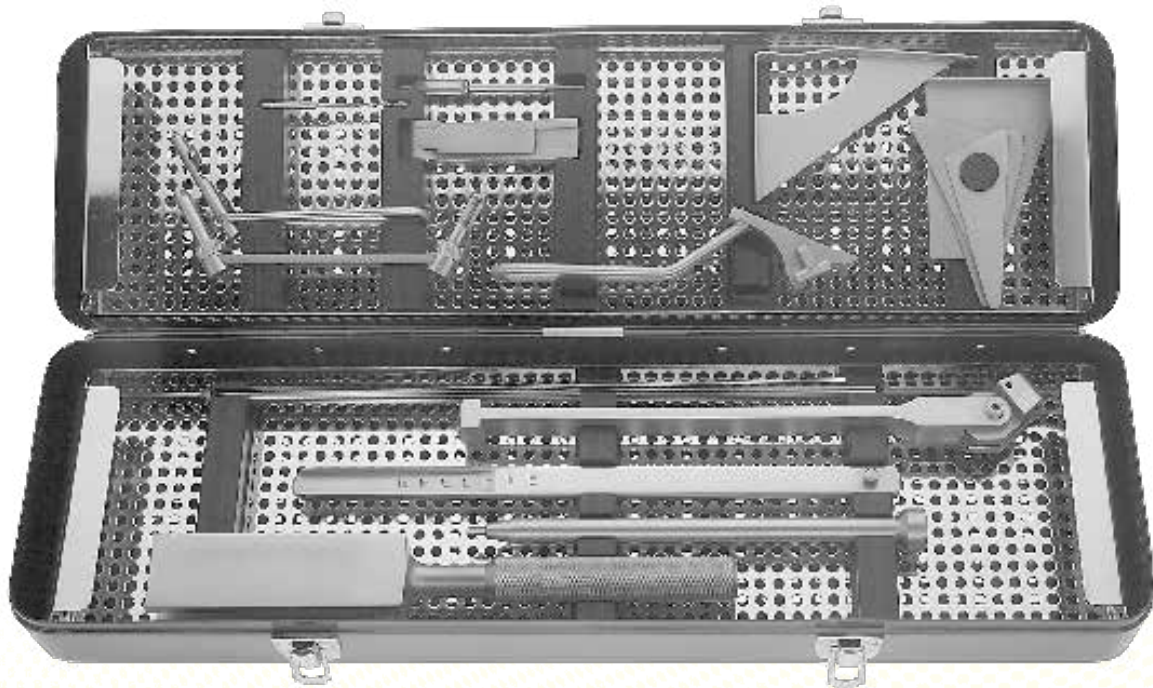

Set Cat. No. T 200

Cat. no. Art. Nr.	included items	QTY St.
T 111	Aluminium Case	1
T 201	Upper Tray	1
T 202	Lower Tray	1
9-294	Triple Drill Guide angle 130°	1
9-264	Drill Guide for Round-Hole Plate	1
9-300	Reamer for Jakobs Chuck	1
9-296	Chisel Guide	1
9-308	Seating Chisel	1
9-306	Impactor-Extractor	1
1-1920	Slotted Hammer	1
9-298	Impactor	1
9-314	Triangular positioning Plate 80/70/30°	1
9-312	Triangular positioning Plate 110/60/20°	1
9-310	Quadrangular positioning Plate 110/90/90/70°	1
9-302	Condylar Plate Guide	1
9-290	DLP Hip Drill Guide 60mm	1
9-316	Triangular positioning Plates 90/50/40°	1
7-127	Kirschner Wire round 2.0mm dia 310mm	10
9-014	Drill Bit AO Shaft Ø 2.0mm dia	1



Cat. no. Art. Nr.	∅	Length Länge	PU VPE
9-294	-	170mm	1

Triple Drill Guide angle 130°
Dreifach Bohrführung gewinkelt 130°



Cat. no. Art. Nr.	∅	Length Länge	PU VPE
9-264	-	130mm	1

Drill Guide for Round-Hole Plate
Gewebeschutzhülse für Rundlochplatte



Cat. no. Art. Nr.	∅	Length Länge	PU VPE
9-300	-	90mm	1

Reamer for Jakobs Chuck
Vorbohrer für Jakobsfutter



Cat. no. Art. Nr.	∅	Length Länge	PU VPE
9-296	-	80mm	1

Chisel Guide
Meißelführung



Cat. no. Art. Nr.	∅	Length Länge	PU VPE
9-308	-	280mm	1

Seating Chisel
Winkelplattensetzinstrument





Cat. no. Art. Nr.	Ø	Length Länge	PU VPE
9-306	-	-	1

Impactor-Extractor
Einschläger-Ausschläger



Cat. no. Art. Nr.	Ø	Length Länge	PU VPE
1-1920	-	260	1

Slotted Hammer
Schlitzhammer



Cat. no. Art. Nr.	Ø	Length Länge	PU VPE
9-298	-	200mm	1

Impactor
Einschläger



Cat. no. Art. Nr.	Ø	Length Länge	PU VPE
9-290	-	-	1

DLP Hip Drill Guide 60mm
Bohrbüchse DLP 60mm





Cat. no. Art. Nr.	∅	Length Länge	PU VPE
9-314	-	80mm	1

Triangular positioning Plate 80°/70°/30°
Zielplatte 80°/70°/30°



Cat. no. Art. Nr.	∅	Length Länge	PU VPE
9-312	-	75mm	1

Triangular positioning Plate 100°/60°/20°
Zielplatte 100°/60°/20°



Cat. no. Art. Nr.	∅	Length Länge	PU VPE
9-316	-	85mm	1

Triangular positioning Plate 90°/50°/40°
Zielplatte 90°/50°/40°



Cat. no. Art. Nr.	∅	Length Länge	PU VPE
9-302	-	110mm	1

Condylar Plate Guide
Kondylen-Zielgerät



Cat. no. Art. Nr.	∅	Length Länge	PU VPE
9-310	-	85 x 65mm	1

Quadrangular positioning Plate 110°/90°/90°/70°
Zielplatte 110°/90°/90°/70°

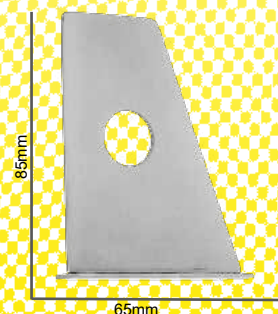



Cat. no. Art. Nr.	Holes Löcher	Length Länge	PU VPE
2-100	-	70mm	1
2-102	-	75mm	1
2-104	-	80mm	1
2-106	-	85mm	1
2-108	-	90mm	1
2-110	-	95mm	1
2-112	-	100mm	1
2-114	-	105mm	1
2-116	-	110mm	1

Femoral Neck Plate 130°
Winkelplatte 130°



Cat. no. Art. Nr.	Holes Löcher	Length Länge	PU VPE
2-120	5	50mm/92mm	1
2-122	5	60mm/92mm	1
2-124	5	70mm/92mm	1
2-126	5	80mm/92mm	1
2-128	7	50mm/124mm	1
2-130	7	60mm/124mm	1
2-132	7	70mm/124mm	1
2-134	7	80mm/124mm	1
2-136	9	50mm/156mm	1
2-138	9	60mm/156mm	1
2-140	9	70mm/156mm	1
2-142	9	80mm/156mm	1
2-144	12	50mm/204mm	1
2-146	12	60mm/204mm	1
2-148	12	70mm/204mm	1
2-150	12	80mm/204mm	1

Condylar Plate 95°
Kondylenplatte 95°



Cat. no. Art. Nr.	Holes Löcher	Length Länge	PU VPE
2-160	4	50mm/75mm	1
2-162	4	60mm/75mm	1
2-164	4	70mm/75mm	1
2-166	4	75mm/75mm	1
2-168	4	80mm/75mm	1
2-170	4	85mm/75mm	1
2-172	4	90mm/75mm	1
2-174	4	95mm/75mm	1
2-176	4	100mm/75mm	1
2-178	4	105mm/75mm	1
2-180	6	50mm/104mm	1
2-182	6	60mm/104mm	1
2-184	6	70mm/104mm	1
2-186	6	80mm/104mm	1
2-188	6	90mm/104mm	1
2-190	9	70mm/152mm	1
2-192	9	80mm/152mm	1
2-194	9	90mm/152mm	1
2-196	12	70mm/200mm	1
2-198	12	80mm/200mm	1
2-200	12	90mm/200mm	1

Angular Plate 130°
Winkelplatte 130°

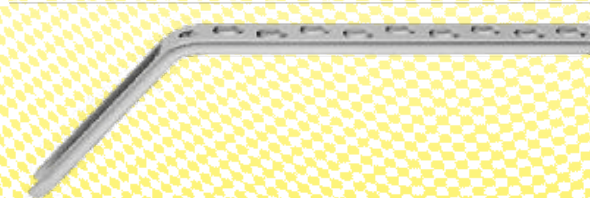



Cat. no. Art. Nr.	°	Length of Blade Klingenlänge	PU VPE
2-222	80°	35mm	1
2-226	90°	35mm	1
2-230	100°	35mm	1
<hr/>			
2-224	80°	45mm	1
2-228	90°	45mm	1
2-232	100°	45mm	1

Angular Plate distal 8mm
Winkelplatte distal 8mm

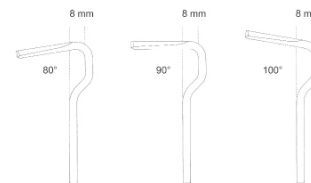

Cat. no. Art. Nr.	°	Length of Blade Klingenlänge	PU VPE
2-236	90°	25mm	1
2-238	90°	32mm	1

Angular Plate distal 7mm
Winkelplatte distal 7mm

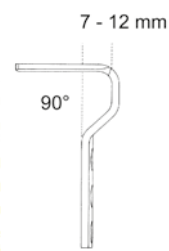

Cat. no. Art. Nr.	°	Length of Blade Klingenlänge	PU VPE
2-240	90°	25mm	1
2-242	90°	32mm	1

Angular Plate distal 12mm
Winkelplatte distal 12mm

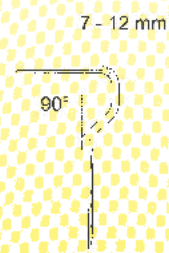
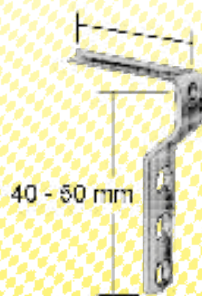

Cat. no. Art. Nr.	°	Length of Blade Klingenlänge	PU VPE
9-307	-	-	1

Insertor/Extractor for Bifurcated Infant Osteotomy Plate
Ein- und Ausschlaginstrument für Kleinkinderplatten



For use Cat. No. 2-236 to 2-242



Cat. no. Art. Nr.	°	Length of Blade Klingenlänge	PU VPE
2-244	90°	40mm	1
2-245	90°	50mm	1
2-246	90°	60mm	1
2-247	90°	60mm	1
2-249	100°	60mm	1

Angular Plate
Winkelplatte

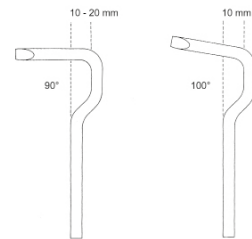

Cat. no. Art. Nr.	°	Length of Blade Klingenlänge	PU VPE
2-250	90°	40mm	1
2-252	90°	50mm	1

Angular Plate distal 10mm
Winkelplatte distal 10mm

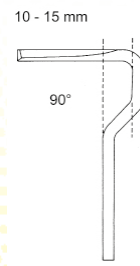
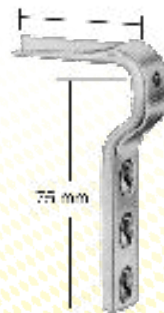

Cat. no. Art. Nr.	°	Length of Blade Klingenlänge	PU VPE
2-254	90°	40mm	1
2-256	90°	50mm	1

Angular Plate distal 15mm
Winkelplatte distal 15mm

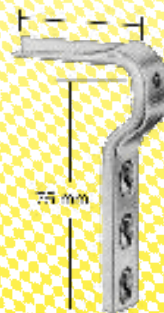

Cat. no. Art. Nr.	°	Length of Blade Klingenlänge	PU VPE
2-266	110°	65mm	1
2-268	110°	75mm	1
2-270	110°	85mm	1
2-260	120°	65mm	1
2-262	120°	75mm	1
2-264	120°	85mm	1
2-272	130°	65mm	1
2-273	130°	70mm	1
2-274	130°	75mm	1
2-275	130°	80mm	1
2-276	130°	85mm	1
2-277	130°	90mm	1
2-278	130°	95mm	1
2-279	130°	100mm	1
2-280	130°	105mm	1
2-281	130°	110mm	1

Angular Plate
Winkelplatte

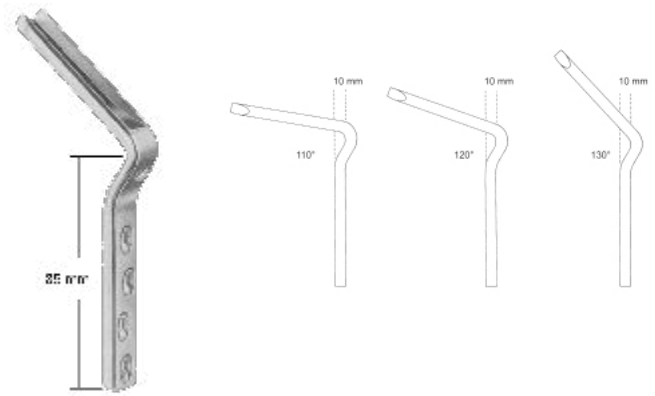

Cat. no. Art. Nr.	∅	Length Länge	PU VPE
9-320	-	250mm	1

Seating Chisel
Meissel



Cat. no. Art. Nr.	∅	Length Länge	PU VPE
9-322	-	250mm	1

Seating Chisel Infant Size
Meissel Kindergröße



Cat. no. Art. Nr.	∅	Length Länge	PU VPE
9-324	-	255mm	1

Insertor-Extractor
Einschläger für Hüftplatten





Cat. no. Art. Nr.		Length Länge	PU VPE
9-325	-	40mm	1

Triangular positioning Plate for Children 90°/50°/40°
Zielplatte für Kinder 90°/50°/40°



Cat. no. Art. Nr.		Length Länge	PU VPE
9-326	-	40mm	1

Triangular positioning Plate for Children 80°/70°/30°
Zielplatte für Kinder 80°/70°/30°



Cat. no. Art. Nr.		Length Länge	PU VPE
9-327	-	40mm	1

Triangular positioning Plate for Children 110°/60°/10°
Zielplatte für Kinder 110°/60°/10°



Cat. no. Art. Nr.		Length Länge	PU VPE
9-328	-	30 x 40mm	1

Quadrangular positioning Plate for Children 110°/90°/90°/70°
Zielplatte für Kinder 110°/90°/90°/70°

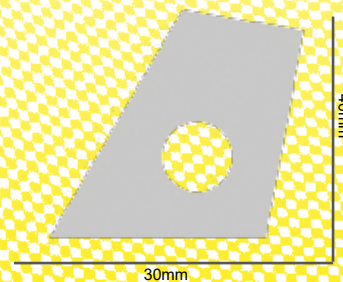



Set Cat. No. T 233

Standard Instrument Set for dynamic Hip and Condylar Screws and Plates
Standard Instrumenten-Set für dynamische Hüft- und Condylarschrauben und Platten

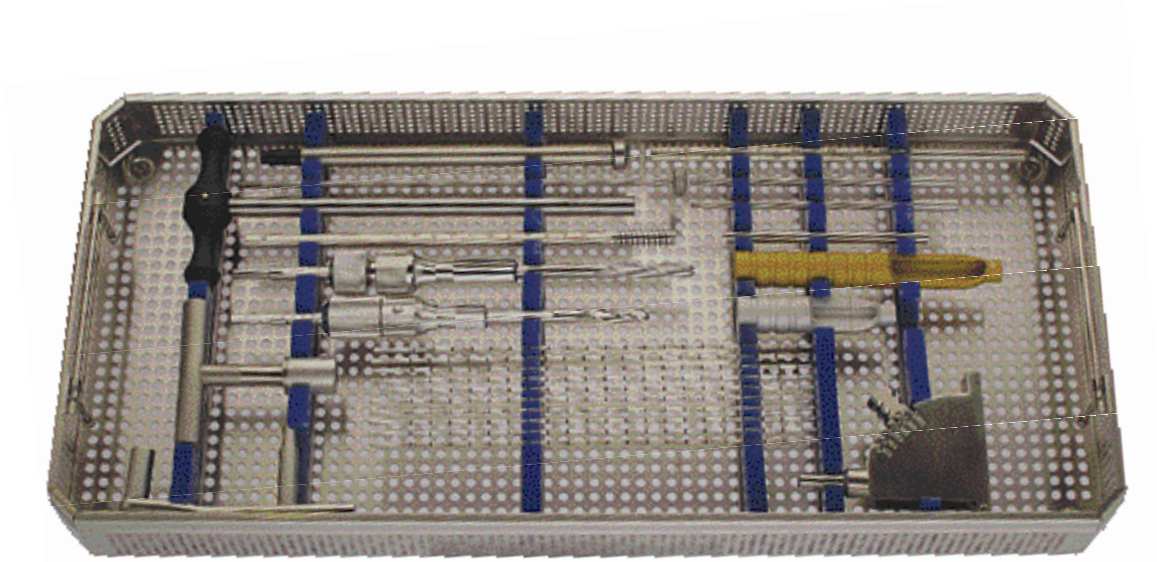

Set Cat. No. T 233

Cat. no. Art. Nr.	included items	QTY St.
T 234	Tray for dynamic Hip Screw Instrument Set T 233	1
2-300	Guide Pin 2.5mm dia 230mm length	10
2-302	Drill Guide adjustable on 125°-150°	1
2-304	Measuring Gauge	1
2-306	Triple Reamer complete, long	1
2-308	Tap	1
2-310	Guide Sleeve short	1
2-312	Guide Sleeve long	1
2-314	Guide Shaft for Coupling Screw	1
2-316	Coupling Screw for Wrench 2-318	1
2-317	Guide Shaft	2
2-318	T-Wrench	1
2-320	Impactor	1
2-322	T-Handle	1
2-486	Targeting Device	1
2-488	Triple Reamer short	1



Sterilization Container (recommended)
15-1870 Bottom non-perforated
580 x 280 x 100 mm
15-1850 Lid perforated
580 x 280mm silver



Set Cat. No. T 230

Instrument Set for DHS
Instrumentensatz für DHS

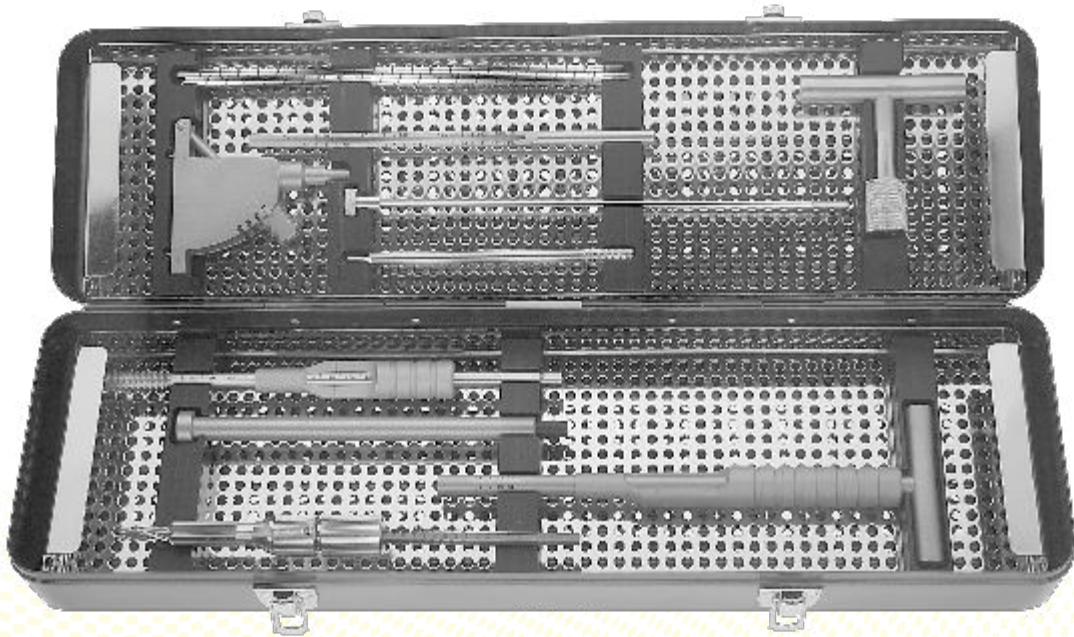

Set Cat. No. T 230

Cat. no. Art. Nr.	included items	QTY St.
T 111	Aluminium Case	1
T 231	Upper Tray	1
T 232	Lower Tray	1
2-300	Guide Pin 2.5mm dia 230mm length	10
2-302	Drill Guide adjustable on 125°-150°	1
2-304	Measuring Gauge	1
2-306	Triple Reamer complete, long	1
2-308	Tap	1
2-310	Guide Sleeve short	1
2-312	Guide Sleeve long	1
2-314	Guide Shaft for Coupling Screw	1
2-316	Coupling Screw for Wrench 2-318	1
2-317	Guide Shaft	2
2-318	T-Wrench	1
2-320	Impactor	1
2-322	T-Handle	1



Cat. no. Art. Nr.	Ø	Length Länge	PU VPE
2-300	2.5mm	220mm	1

Guide Pin 2.5mm dia 230mm length
Führungsdraht 2.5mm dia 230mm Länge



Cat. no. Art. Nr.	Ø	Length Länge	PU VPE
2-302	-	-	1

Drill Guide adjustable on 125°-150°
Bohrbüchse verstellbar 125°-150°

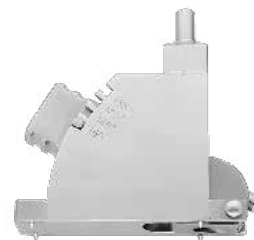

Cat. no. Art. Nr.	Ø	Length Länge	PU VPE
2-304	-	200mm	1

Measuring Gauge
Messlehre



Cat. no. Art. Nr.	Ø	Length Länge	PU VPE
2-306	-	240mm	1

Triple Reamer complete long
Dreistufenfräser lang



Cat. no. Art. Nr.	Ø	Length Länge	PU VPE
2-308	-	230mm	1

Tap
Gewindeschneider





Cat. no. Art. Nr.	∅	Length Länge	PU VPE
2-310	-	85mm	1

Guide Sleeve short
Führungshülse kurz



Cat. no. Art. Nr.	∅	Length Länge	PU VPE
2-312	-	140mm	1

Guide Sleeve long
Führungshülse lang



Cat. no. Art. Nr.	∅	Length Länge	PU VPE
2-314	-	110mm	1

Guide Shaft for Coupling Screw
Führungsschaft für Verbindungsschrauben



Cat. no. Art. Nr.	∅	Length Länge	PU VPE
2-316	-	240mm	1

Coupling Screw for Wrench 2-318
Verbindungsschraube für Schlüssel 2-318



Cat. no. Art. Nr.	∅	Length Länge	PU VPE
2-317	-	140mm	1

Guide Shaft
Führungsschaft





Cat. no. Art. Nr.	Ø	Length Länge	PU VPE
2-318	-	-	1

T-Wrench
T-Schlüssel



Cat. no. Art. Nr.	Ø	Length Länge	PU VPE
2-320	-	200mm	1

Impactor
Einschläger



Cat. no. Art. Nr.	Ø	Length Länge	PU VPE
2-322	-	-	1

T-Handle
T-Griff

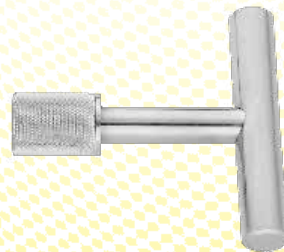

Cat. no. Art. Nr.	Ø	Length Länge	PU VPE
2-332	-	-	1

Drill Guide adjustable to 125°/130°/135°
Verstellbares Zielgerät 125°/130°/135°





Cat. no. Art. Nr.	Ø	Length Länge	PU VPE
2-313	-	90mm	1

Guide Sleeve new Type
Führungshülse neu



Cat. no. Art. Nr.	Ø	Length Länge	PU VPE
2-315	-	230mm	1

T-Wrench new Type for 2-328
Führungshülse neu für 2-328



Cat. no. Art. Nr.	Ø	Length Länge	PU VPE
2-328	-	250mm	1

Coupling Screw new Type for 2-315
Kupplungsschraube neu für 2-315



Cat. no. Art. Nr.	Ø	Length Länge	PU VPE
2-319	-	260mm	1

Impactor
Einschläger





Set Cat. No. T 2400

Dynamic Hip Screw Standard Implant Set
Dynamischer Hüftschrauben-Plattensatz



Set Cat. No. T 2400

Cat. no. Art. Nr.	included items	QTY St.
T 2410	Tray for dynamic Hip Screw Standard Set	1
Dynamic Leg Screws thread length 22mm		
2-406	Lag Screw 65mm, 22mm thread	1
2-408	Lag Screw 70mm, 22mm thread	1
2-410	Lag Screw 75mm, 22mm thread	1
2-412	Lag Screw 80mm, 22mm thread	1
2-414	Lag Screw 85mm, 22mm thread	2
2-416	Lag Screw 90mm, 22mm thread	2
2-418	Lag Screw 95mm, 22mm thread	2
2-420	Lag Screw 100mm, 22mm thread	2
2-422	Lag Screw 105mm, 22mm thread	1
2-424	Lag Screw 110mm, 22mm thread	1
2-426	Lag Screw 115mm, 22mm thread	1
Compression Screw		
2-440	Compression Screw	3
Dynamic Hip Screw Plates 135°		
2-352	Dynamic Hip Plate 4 Holes 135°	3
2-354	Dynamic Hip Plate 5 Holes 135°	2
2-356	Dynamic Hip Plate 6 Holes 135°	2
Dynamic Hip Screw Plates 150°		
2-382	Dynamic Hip Plate 4 Holes 150°	1
2-384	Dynamic Hip Plate 5 Holes 150°	1
2-386	Dynamic Hip Plate 6 Holes 150°	1

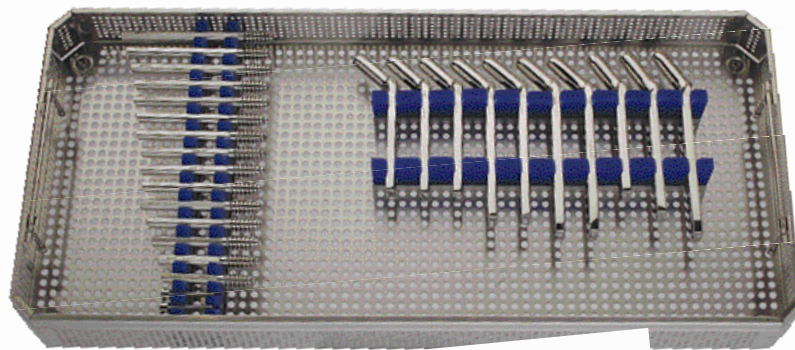

Sterilization Container (recommended)

15-1870	Bottom non-perforated 580 x 280 x 100 mm
15-1850	Lid perforated 580 x 280mm silver



Set Cat. No. T 2500

Dynamic Condylar Screw Standard Implant Set
Dynamischer Kondylenschrauben Standard-Implantatesatz



Set Cat. No. T 2500

Cat. no. Art. Nr.	included items	QTY St.
T 2510	Tray for dynamic Condylar Screw Standart Set	1
Dynamic Leg Screws thread lenght 22mm		
2-400	Lag Screw 50mm, 22mm thread	2
2-402	Lag Screw 55mm, 22mm thread	2
2-404	Lag Screw 60mm, 22mm thread	2
2-406	Lag Screw 65mm, 22mm thread	2
2-408	Lag Screw 70mm, 22mm thread	2
2-410	Lag Screw 75mm, 22mm thread	1
2-440	Compression Screw	5
Dynamic Condylar Screw Plates 95°		
2-450	DCS Plate 6 Holes 100mm 95°	2
2-452	DCS Plate 8 Holes 130mm 95°	2
2-454	DCS Plate 10 Holes 163mm 95°	2
2-456	DCS Plate 12 Holes 198mm 95°	1
2-458	DCS Plate 14 Holes 225mm 95°	1
2-460	DCS Plate 16 Holes 260mm 95°	1

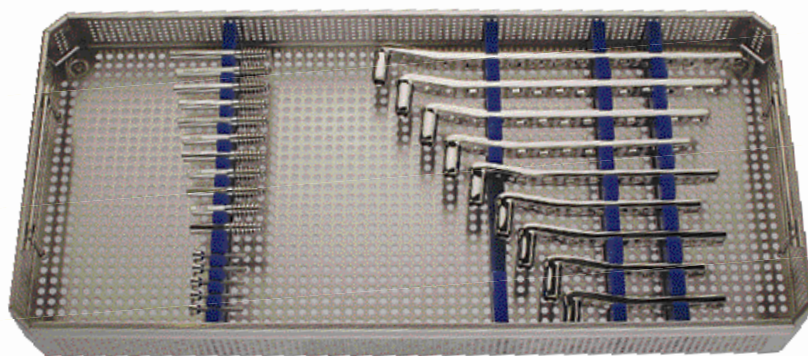

Sterilization Container (recommended)

15-1870	Bottom non-perforated	580 x 280 x 100 mm
15-1850	Lid perforated	580 x 280mm silver



Cat. no. Art. Nr.	°	Holes Löcher	PU VPE
2-350	135°	2	1
2-380	150°	2	1
2-334	125°	4	1
2-340	130°	4	1
2-352	135°	4	1
2-368	140°	4	1
2-374	145°	4	1
2-382	150°	4	1
2-336	125°	5	1
2-342	130°	5	1
2-354	135°	5	1
2-370	140°	5	1
2-376	145°	5	1
2-384	150°	5	1
2-338	125°	6	1
2-344	130°	6	1
2-356	135°	6	1
2-372	140°	6	1
2-378	145°	6	1
2-386	150°	6	1
2-358	135°	8	1
2-388	150°	8	1
2-360	135°	10	1
2-390	150°	10	1
2-362	135°	12	1
2-392	150°	12	1
2-364	135°	14	1
2-366	135°	16	1

Dynamic Hip Plate
Dynamische Hüftplatte





Cat. no. Art. Nr.	°	Holes Löcher	PU VPE
2-394	135°	4	1
2-396	135°	5	1
2-398	135°	6	1

Dynamic Hip Plate 135°
Dynamische Hüftplatte 135°



Cat. no. Art. Nr.	°	Holes Löcher	PU VPE
2-399	-	-	1

Trochanter Plate
Trochanterplatte

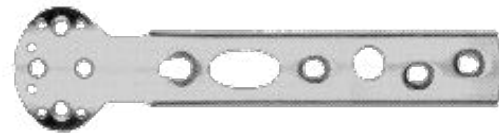

Cat. no. Art. Nr.	∅	Length Länge	PU VPE
2-400	-	50mm	1
2-402	-	55mm	1
2-404	-	60mm	1
2-406	-	65mm	1
2-408	-	70mm	1
2-410	-	75mm	1
2-412	-	80mm	1
2-414	-	85mm	1
2-416	-	90mm	1
2-418	-	95mm	1
2-420	-	100mm	1
2-422	-	105mm	1
2-424	-	110mm	1
2-426	-	115mm	1
2-428	-	120mm	1
2-430	-	125mm	1
2-432	-	130mm	1
2-434	-	134mm	1
2-436	-	140mm	1
2-438	-	145mm	1

Leg Screw 22mm thread
Zugschraube 22mm Gewinde



Cat. no. Art. Nr.	∅	Length Länge	PU VPE
2-440	-	-	1

Compression Screw
Kompressionsschraube





Cat. no. Art. Nr.	Holes Löcher	Length Länge	PU VPE
2-450	6	100mm	1
2-452	8	130mm	1
2-454	10	163mm	1
2-456	12	198mm	1
2-458	14	225mm	1
2-460	16	260mm	1
2-462	18	306mm	1
2-464	20	336mm	1
2-466	22	370mm	1

DCS Plate 95°
DCS Platte 95°



Cat. no. Art. Nr.	Holes Löcher	Length Länge	PU VPE
2-486	-	-	1

Targeting Device for DCS Plate
Zielgerät für DCS-Platte



Cat. no. Art. Nr.	°	Length Länge	PU VPE
2-470	135°	105mm	1
2-472	140°	105mm	1
2-474	145°	105mm	1
2-476	150°	105mm	1

Drill Guide for DCS Plate
Bohrbüchse für DCS Platte

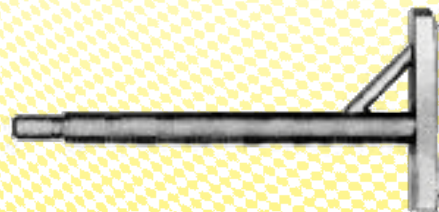

Cat. no. Art. Nr.	Holes Löcher	Length Länge	PU VPE
2-488	-	240mm	1

Triple Reamer short
Dreistufenfräser kurz





TREU-Instrumente GmbH
take-off Gewerbepark 130-132
78579 Neuhausen ob Eck
Germany

Phone +49 (0) 74 67/947 673 0
Fax +49 (0) 74 67/947 673 50

www.treu.com
info@treu.com